

C4RT9 TOUCHSCREEN CONSOLE

 TRUE®



MODEL C4RT9
(MAN-C4RT9 REV02)

**OWNER'S
MANUAL**

IMPORTANT!

All products shown are prototype. Actual product delivered may vary.
Product specifications, features, and software are subject to change without notice.
For the current owner's manual and documents in additional languages please visit
<https://shop.truefitness.com/customer-service/user-manuals/>

IMPORTANTE!

Todos los productos mostrados son prototipos. La realidad el producto suministrado puede diferir. Especificaciones de productos, características y software están sujetas a cambios sin previo aviso.
Para la más actualizada de este manual del propietario y para los documentos en otros idiomas, por favor visite
<https://shop.truefitness.com/customer-service/user-manuals/>

IMPORTANT! Tous les produits présentés sont prototype. Le produit réel livré peut varier. Spécifications du produit, caractéristiques et logiciels sont sujettes à modification sans préavis. Pour la plus à jour le manuel du propriétaire et pour documents dans des langues supplémentaires, veuillez <https://shop.truefitness.com/customer-service/user-manuals/> de visite

重要提示!

显示所有产品的原型。实际交付的产品可能有所不同产品规格,功能和软件如有更改,恕不另行通知迄今为止对于大多数的使用说明书,和对于其他语言的文档,请访问<https://shop.truefitness.com/customer-service/user-manuals/>

اہم!

اہم کی لسٹ میں پیش کردہ تمام آلات فلٹخت دق۔ جو ذمہ دار ہے۔ وضو و عملہ تاجت نما اعمی ج۔
راعش! نود ری غت لل طلباق چار بل او تازی مل او، جت نما تافص او م۔
<https://shop.truefitness.com/customer-service/user-manuals/> قرایز ی جری لک ل مل ل لی ل ن ال ا ی تح ل ص ی ام مظ عمل
<https://shop.truefitness.com/customer-service/user-manuals/> قرایز ی جری، فی فاض! تاغل یف تادنت س مل ل

WICHTIG!

Alle hier gezeigten Produkte sind Prototypen. Das tatsächliche Produkt ausgeliefert wird, kann variieren. Produkt-Spezifikationen, Funktionen und Software können sich ohne vorherige Ankündigung ändern. In den meisten Fällen bis zu Bedienungsanleitung Bisher besuchen und für Dokumente in weiteren Sprachen finden Sie unter
<https://shop.truefitness.com/customer-service/user-manuals/>

BELANGRIJK!

Alle getoonde producten zijn prototype. Daadwerkelijke product geleverd kan verschillen. Product specificaties, eigenschappen & software zijn onderhevig aan verandering zonder kennisgeving. Voor de meest actuele handleiding van de eigenaar & voor documenten in andere talen kunt u terecht op
<https://shop.truefitness.com/customer-service/user-manuals/>

ВАЖНО!

Все товары указаны прототипа. Фактический продукт, поставляемый могут отличаться. Технические характеристики, особенности и программного обеспечения могут быть изменены без предварительного уведомления. Для получения самой последней на сегодняшний день руководство по эксплуатации и Для документов на другие языки, пожалуйста, посетите <https://shop.truefitness.com/customer-service/user-manuals/>

Thank You for Choosing TRUE!

Since our founding in 1981, TRUE Fitness has been guided by two core principles: Build the highest quality products and support them with superior service. Today, TRUE is the global leader in premium cardio equipment for the commercial and residential markets.

Built on decades of experience and constantly refined over time, our machines have a reputation for exceptional reliability. Our treadmills, ellipticals, and bikes face rigorous and systematic life-testing to guarantee they withstand the demands of long-term, extended use -- whether at the gym or in your home.

Thank you for becoming a part of the TRUE experience.

Contacting Our Support Team

Before you contact TRUE, we recommend gathering the serial number, model number, and a brief description of the reason for your request. After you have all the pertinent information, we suggest you contact your selling dealer or local service company to set up an appointment. If you are not familiar with who is in your area, you can visit <https://shop.truefitness.com/store-locator/> and use our store locator to obtain the contact information for the closest dealer.

If you still need help, please contact our product support team.

Address	TRUE Fitness Attn: Product Support 865 Hoff Road St. Louis, MO 63366
Phone	800.883.8783
Email	service@truefitness.com
Hours of Operation	Monday - Friday 8:30am - 5:00pm (CST)

Contacting Our Sales Team

Interested in owning more TRUE products? Please contact us with any product inquiries so that we may direct you to the appropriate sales representative to help answer your questions.

Address	TRUE Fitness Attn: Sales Department 865 Hoff Road St. Louis, MO 63366
Phone	800.426.6570
Email	sales@truefitness.com
Hours of Operation	Monday - Friday 8:30am - 5:00pm (CST)

Reporting Freight Claims or Parts Damage

Unfortunately, sometimes materials can be damaged during shipment. If materials are damaged during shipment, please follow the guidelines below to determine the appropriate process for you to follow.

Severe Damage—Obvious damage to external packaging and internal product.

Please refuse the shipment and it will be returned to TRUE by the carrier. Contact TRUE product support by calling 800.883.8783 or sales support by calling 800.426.6570 Monday-Friday during normal business hours to notify us that the shipment has been refused. Once we have received the damaged shipment, a replacement shipment will be sent to you. If the shipment comes in multiple boxes, only refuse boxes with damage.

Slight Damage—Minimal damage to external packaging with unknown internal damage to product.

If the shipment has minimal damages and you are not sure if the actual product is damaged, you must sign the bill of lading as damaged when accepting the shipment. Once you have opened the box and you have determined something is indeed damaged, please gather the serial number, model number, description of damage, and photos of damage.

Please make sure the photos include the damaged product as well as the damaged box the product arrived in. Contact TRUE product support (service@truefitness.com // 800.883.8783) or TRUE sales support (sales@truefitness.com // 800.426.6570) Monday-Friday during normal business hours.

Concealed Damage—No damage to external packaging but internal damage to product.

You may receive a shipment that looks intact and discover once the box has been opened that there are hidden damages. Please notify the carrier immediately. TRUE will not be able to file a claim if the carrier is not notified in a timely manner.

Once you have called the carrier you will need to gather the serial number, model number, description of damage, and photos of damage. Contact TRUE product support (service@truefitness.com // 800.883.8783) or TRUE sales support (sales@truefitness.com // 800.426.6570) Monday-Friday during normal business hours.

TABLE OF CONTENTS

SAFETY INSTRUCTIONS

IMPORTANT SAFETY INSTRUCTIONS—SAVE THESE INSTRUCTIONS.....	7
POWER REQUIREMENTS.....	9
GROUNDING INSTRUCTIONS.....	9
WARNING AND INTENDED USE LABELS.....	10
COMPLIANCES.....	11

ASSEMBLY INSTRUCTIONS

PREASSEMBLY CHECKLIST.....	12
ASSEMBLY STEPS.....	13

CONSOLE OVERVIEW

CONSOLE OVERVIEW.....	21
-----------------------	----

PROGRAMMING AND OPERATION

TOUCHSCREEN INTRODUCTION.....	22
TOUCHSCREEN NAVIGATION.....	22
HEART RATE MONITORING.....	23
HEART RATE CONTROL (HRC).....	24
PROGRAM DESCRIPTIONS.....	25

TOUCHSCREEN CONSOLE

CONSOLE NAVIGATION.....	27
USER PROFILES.....	30
BLUETOOTH FUNCTIONS.....	31
ADVANCED CONSOLE FUNCTIONS.....	33

WARRANTY

NOTICE.....	39
-------------	----

SAFETY INSTRUCTIONS

IMPORTANT SAFETY INSTRUCTIONS—SAVE THESE INSTRUCTIONS

This equipment is intended for a commercial or institutional setting. This owner's manual should be accessible to all personal trainers, faculty, and members.

- Read and understand all instructions and warnings prior to use.
- Obtain a medical exam before beginning any exercise program. If at any time during exercise you feel faint, dizzy, or experience pain, stop and consult your physician.
- Obtain proper instruction prior to use.
- This unit is intended for commercial use only.
- Inspect the unit for incorrect, worn, or loose components and do not use until corrected, replaced, or tightened prior to use.
- Do not wear loose or dangling clothing while using the unit.
- Care should be used when mounting or dismounting the unit.
- Read, understand, and test the emergency stop procedures before use.
- Disconnect all power before servicing the unit.
- Do not exceed maximum user weight of 350 lbs (159 kg).
- Keep the top side of the moving surface clean and dry.
- Keep children and animals away.
- Use caution when moving and assembling unit.
- All exercise equipment is potentially hazardous. If attention is not paid to the conditions of equipment usage, death, or serious injury could occur.

⚠ DANGER: To reduce the risk of electric shock, always unplug this product when not in use, before cleaning, or attempting any maintenance activity. Do not handle the plug with wet hands.

⚠ WARNING: To reduce the risk of burns, fire, and electric shock or injury to persons, follow these instructions:

- Heart rate monitoring systems may be inaccurate. Over-exercising may result in serious injury or death. If you feel faint, dizzy, or experience pain, stop exercising immediately.
- Health related injuries may result from incorrect or excessive use of exercise equipment.
- TRUE STRONGLY recommends seeing a physician for a complete medical exam before undertaking an exercise program, particularly if the user has a family history of high blood pressure or heart disease, is over the age of 45, smokes, has high cholesterol, is obese or has not exercised regularly in the past year. Additionally, TRUE recommends consulting a fitness professional on the correct use of this product.
- Equipment should be immediately taken out of use if it fails to work properly or when a warning is presented electronically.
- When using this exercise machine, basic precautions should always be followed.
- Use this equipment only for its intended use as described in this manual.
- Do not move the equipment by lifting the console. Do not use the console as a handlebar during a workout.
- This product can expose you to chemicals including Toluene and Acrylamide which are known to the State of California to cause Cancer and birth defects or other reproductive harm. For more information, go to www.P65Warnings.ca.gov.
- Keep equipment stable on flat ground.
- Risk of personal injury-crushing hazard when equipment is in operation. Keep feet, hands, and fingers away from moving parts.
- Replace warning labels that may be worn, damaged, or missing.
- Replace any non-working or damaged components, remove the unit from service until repair is performed.
- Do not operate the equipment while being covered with a blanket, pillow, plastic, or anything that insulates or stops airflow. Keep air openings free of lint, hair or any obstructing material.
- To avoid serious injury, remove and store the power cord when the machine is not in use.
- This appliance should never be left unattended when plugged in.
- Do not use any type of extension cord with this product.
- Never operate a TRUE product if it has a damaged power cord or electrical plug, or if it has been dropped, damaged, or even partially immersed in water.
- Use a TRUE AC power cord or AC/DC adapter only.
- Position this product so the power cord plug is accessible to the user.

- Keep the power cord away from heated surfaces. Do not pull the equipment by the power cord or use the cord as a handle. Do not run the power cord along the side or under the equipment.
- If the electrical supply cord is damaged it must be replaced by the manufacturer, an authorized service agent, or a similarly qualified person to avoid a hazard.
- This product must be connected to a properly grounded electrical outlet.
- To disconnect, turn power OFF at the ON/OFF switch if applicable, then remove plug from electrical outlet. On the machine power switch, (I) means that the machine power is **ON** and (O) means the machine power is **OFF**.

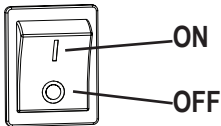

- Never insert objects into any openings in this product. If an object should drop inside, turn off the power, unplug the power cord from the outlet and carefully retrieve it. If the item cannot be reached, contact TRUE product support.
- Any changes or modifications to this equipment could void the product warranty.
- Do not use this product in areas where aerosol spray products are being used or where oxygen is being administered. Such substances create the danger of combustion and explosion.
- Do not use this product outdoors, near water, while wet, or in areas of high humidity including extreme temperature changes.
- Close supervision is necessary when used near children under the age of 15, or disabled persons.
- This equipment is not intended for use by persons with reduced physical, sensory, or mental capabilities, or lack of experience and knowledge, unless they are supervised or have been given instruction concerning use of the equipment by a person responsible for their safety.
- Children shall not play with the appliance.
- Cleaning and user maintenance shall not be made by children without supervision.
- Wear shoes with rubber or high traction soles. Do not use shoes with heels, leather soles, cleats or spikes. Make sure no stones are embedded in the soles. Do not use this product in bare feet. Keep all loose clothing, shoelaces and towels away from moving parts.
- To avoid injury, attach the safety clip to clothing before use.
- When mounting the treadmill, ensure the treadmill belt is not running.
- Use handlebars to maintain balance when mounting and dismounting the treadmill and for additional stability while exercising.
- To avoid injury, stand on the side rails before starting the equipment.

- While the treadmill is in use, proceed at a speed that the user can safely maintain with the ability to immediately engage the safety key to stop the treadmill belt if necessary.
- Avoid the possibility of bystanders being struck or caught between moving parts by making sure that they are out of reach of the equipment while it is in motion.
- Do not use typing or web surfing features at excessive speeds. Always stabilize yourself when using typing or web surfing features. (Varies by console option.)
- Never place liquids of any type directly on the unit except in the accessory tray or bottle holders. Containers with lids are recommended.
- Always follow the console instructions for proper operation.
- Do not use the contact heart rate grips as a handlebar during a workout.
- Avoid exiting equipment while leaving the tread belt in motion.
- Never walk or jog backwards on the equipment.
- Allow only one person at a time on the equipment while it's operating.
- Do not allow animals on or near the equipment while in operation.
- To avoid serious injury, do not touch the incline rack while the equipment is in use.

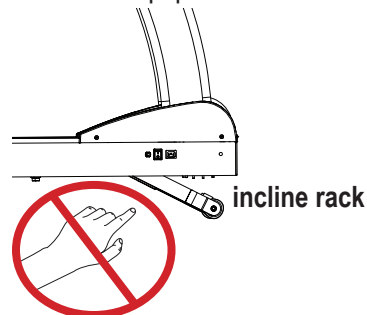

- To avoid serious injury, do not touch the belt while the equipment is in use.

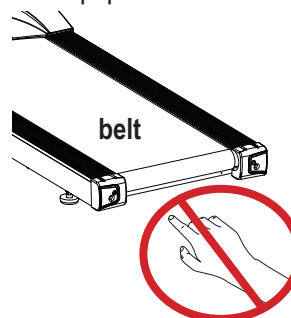

- Do not reach into or underneath the unit, or tip it on its side during operation.
- Do not use if you have a cold or fever.
- Do not change the incline of the equipment by placing objects under it.
- Do not use attachments not recommended by the manufacturer.
- Allow only trained personnel to service this equipment.

- It is the sole responsibility of the owner/operator to ensure regular and scheduled maintenance is performed.
- Do not remove the motor cover or you may risk injury due to electric shock. Please contact TRUE product support if the motor area needs servicing.
- Noise emission under load is higher than without load. A-weighted emission sound pressure level at the trainer's ear: 67 dBA.

POWER REQUIREMENTS

Read and understand all instructions before plugging any TRUE power cord into an electrical outlet.

DEDICATED LINE

This product requires a dedicated line. A dedicated line assures that adequate power is available for safe operation over the life of your TRUE product.

GROUNDING INSTRUCTIONS

This product must be grounded. If the product malfunctions or breakdowns, grounding provides a path of least resistance for electric current to reduce the risk of electric shock. This product is equipped with a cord having an equipment grounding conductor and a grounding plug. The plug must be plugged into an appropriate outlet that is properly installed and grounded in accordance with all local codes and ordinances.

DANGER:

- Improper connection of the equipment grounding conductor can result in risk of electrical shock.
- Check with a qualified electrician or service provider if you are in doubt as to whether the equipment is properly grounded or installed on a dedicated line.
- Seek a qualified electrician to perform any modifications to the cord or plug. TRUE is not responsible for injuries or damages as a result of cord or plug modification.
- To reduce the risk of burns, fire, electric shock, or injury, it is imperative to connect each product to a properly grounded 110V or 220V electrical outlet. The voltage required for your unit is located on the serial number decal (usually on the front of the unit). Depending on where you live voltage requirements differ.
- Some TRUE products require a circuit rated 110V, 60 Hz, and 20 amps. In the United States, most residential homes have circuits rated 110V, 60 Hz, and 15 amps. If your unit requires a 20 amp outlet, contact an electrician to install a dedicated 20 amp circuit prior to use.
- **110 Volt**—This model is for use on a nominal 110V circuit and has a grounding plug that looks like the plug illustrated below. Make sure the product is connected to an outlet having the same configuration as the plug. No adapter should be used with this product.

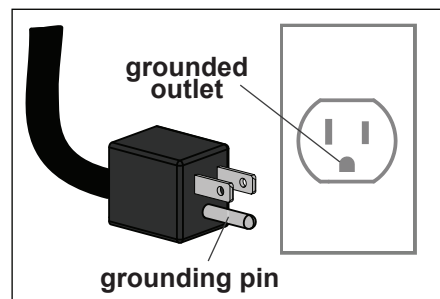

Power Information						
Model	Line Voltage (V)	Frequency (Hz)	Rated Current (Amps)	Number of Units per Circuit	Plug/Outlet*	Max Power Dissipation (Watt)
TPS1000/3000/8000	110	50/60Hz	15	Dedicated 1	NEMA 5-15 	1230

*The plug configuration for the power adapter may vary by country.

WARNING AND INTENDED USE LABELS

! WARNING: Replace warning labels that may be worn, damaged, or missing.

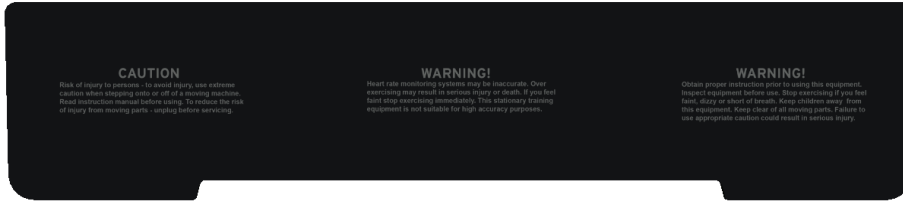

To replace any worn or missing warning labels, locate the serial number for your product, and then contact TRUE product support:

- www.truefitness.com
- 800.883.8783
- service@truefitness.com

NOTE: Additional console serial number located at the bottom of the console.

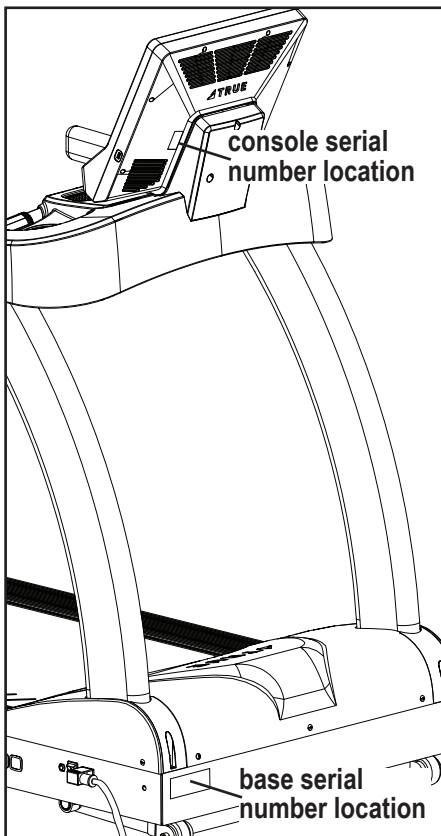

23-000000X

TRUE
 TRUE FITNESS TECHNOLOGY, INC
 865 HOFF RD, ST LOUIS MISSOURI 63366 USA
 MODEL NO: TPS1000
 SERIAL NO: 22-TPS10001A

TRUE
 TRUE FITNESS TECHNOLOGY, INC
 865 HOFF RD, ST LOUIS MISSOURI 63366 USA
 MODEL NO: TPS3000
 SERIAL NO: 22-TPS30001A

TRUE
 TRUE FITNESS TECHNOLOGY, INC
 865 HOFF RD, ST LOUIS MISSOURI 63366 USA
 MODEL NO: TPS8000
 SERIAL NO: 22-TPS80001A

WARNING AND INTENDED USE LABELS CONTINUED

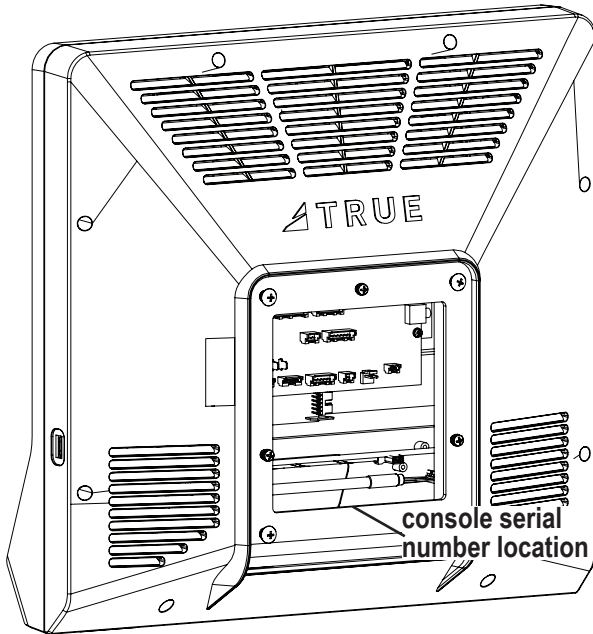

S/N: 
23-000000X

MDL: 
C4RT9

COMPLIANCES

This equipment complies with all applicable codes and regulations. For a complete list of compliances, please see regulatory approvals on truefitness.com.

ASSEMBLY INSTRUCTIONS



NOTE: Supplemental video available on vimeo.com: <https://vimeo.com/869706867?share=copy>.

PREASSEMBLY CHECKLIST

VERIFY BOX CONTENTS

IMPORTANT! Please verify box contents. If you have questions, or if there are any missing parts, contact product support at 800.883.8783 or service@truefitness.com.

TOOLS NEEDED FOR ASSEMBLY		INCLUDED IN BOX
#2 Phillips Screwdriver		NO

BOX CONTENTS

ITEM	PART NUMBER	DESCRIPTION	QTY
1	C4RT9	CONSOLE, UCIV, RETAIL 9"TS	1
2	MAN-C4RT9	MANUAL, C4RT9	1

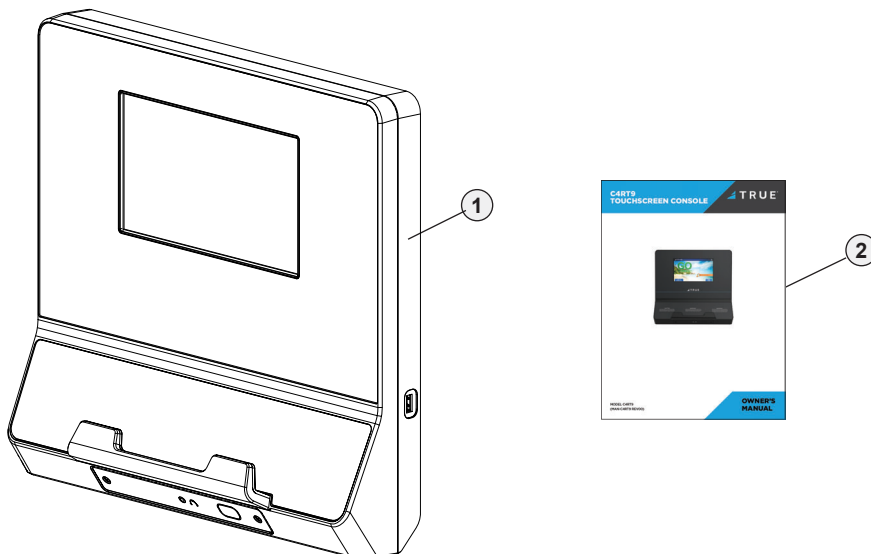

ASSEMBLY STEPS

STEP 1—ATTACH CONSOLE TO CONSOLE MAST

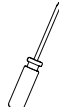
Tools Used in this Step	
#2 Phillips Screwdriver	

Parts Used in this Step		
Part	Description	Qty
N/A	CONSOLE	1

Using a #2 Phillips screwdriver, secure the console to the console mast using the hardware preassembled to the console (00567800 // SCREW, M5-.8X12 COMBO PHILLIPS/Common TRUSS HEAD - ACG BLACK // QTY 4).

NOTE: If the console also has three screws (00567700 // SCREW, M4-.7 X 12 PPHMS SEMS // QTY 3) preassembled, remove and set aside these screws. They are not used in this installation.

NOTE: Loosen but do not remove the bottom two preassembled screws (00567800), those slide into the keyhole slots on the console mast.

NOTE: Ensure all cables are routed inside the console mast to avoid pinching the cables.

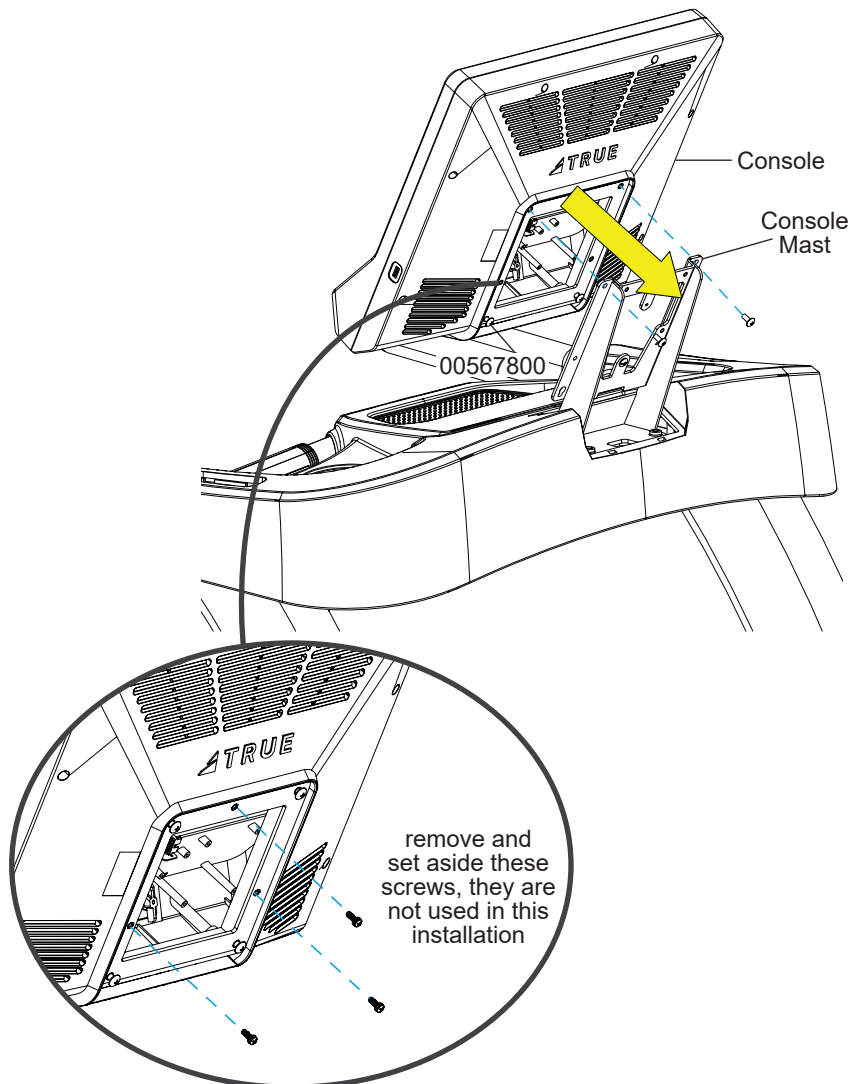

STEP 2—MAKE CONSOLE CABLE CONNECTIONS

1. Connect the I/O cable, center pod cable, contact heart rate cable, and safety key cable to their respective ports on the console control board.

NOTE: The longer safety key connector pictured below is only used for the touchscreen console. The shorter connector will not be used.

2. Connect the ground wire ring terminal to the preinstalled, grounded screw on the console mast, ensuring the grounded screw secures the ground wire ring terminal to the front console mast. Ensure the ground wire ring is connected.

NOTE: Coaxial cable connections are not available on the touchscreen console at this time.

NOTE: Ensure there is power going to the machine. See the base owner's manual for power cord info.

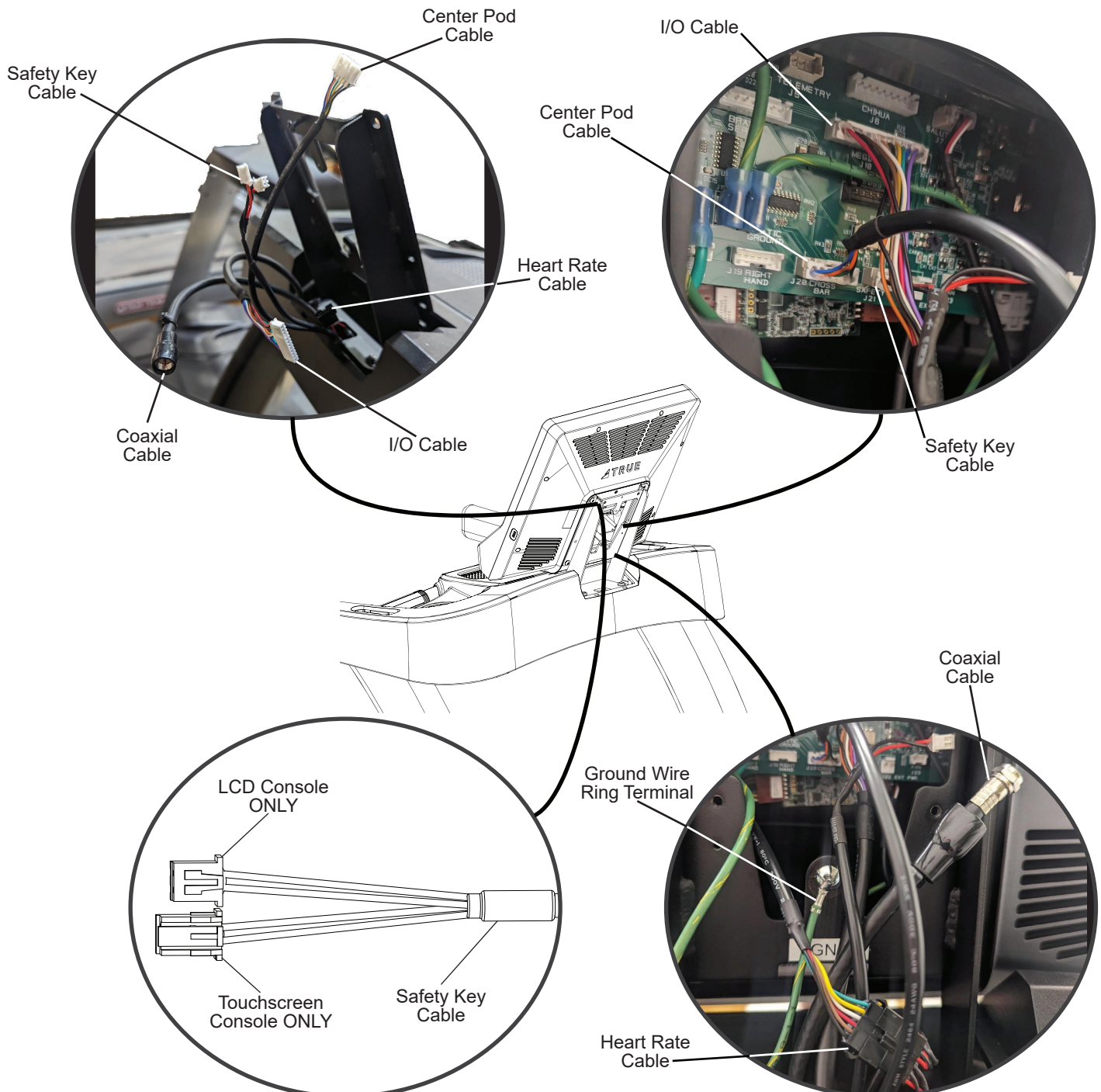

STEP 3—CALIBRATE THE TREADMILL



NOTE: Supplemental video available on vimeo.com: <https://vimeo.com/869677132?share=copy>.

PART	DESCRIPTION	QTY
N/A	CONSOLE	1

IMPORTANT! CALIBRATION IS REQUIRED AFTER THE CONSOLE IS INSTALLED TO THE BASE.

NOTE: Users must select the correct base in configuration prior to calibration.

To enter configuration:

1. If you're placing the console on the machine for the first time, select the correct base model and follow the on-screen instructions to complete the procedure.
- OR
1. To enter Service Mode, press and hold the **TRUE** logo (A) in the upper left corner of the home screen. When the word **TRUE** (B) begins to flash, release the logo and press and hold the lower right corner of the screen (C).



STEP 3—CALIBRATE THE TREADMILL CONTINUED

2. The first screen displayed after entering Service Mode is the Service menu. In the Service menu, select **Utilities** (A) to highlight it. Press **NEXT** (B) to continue.

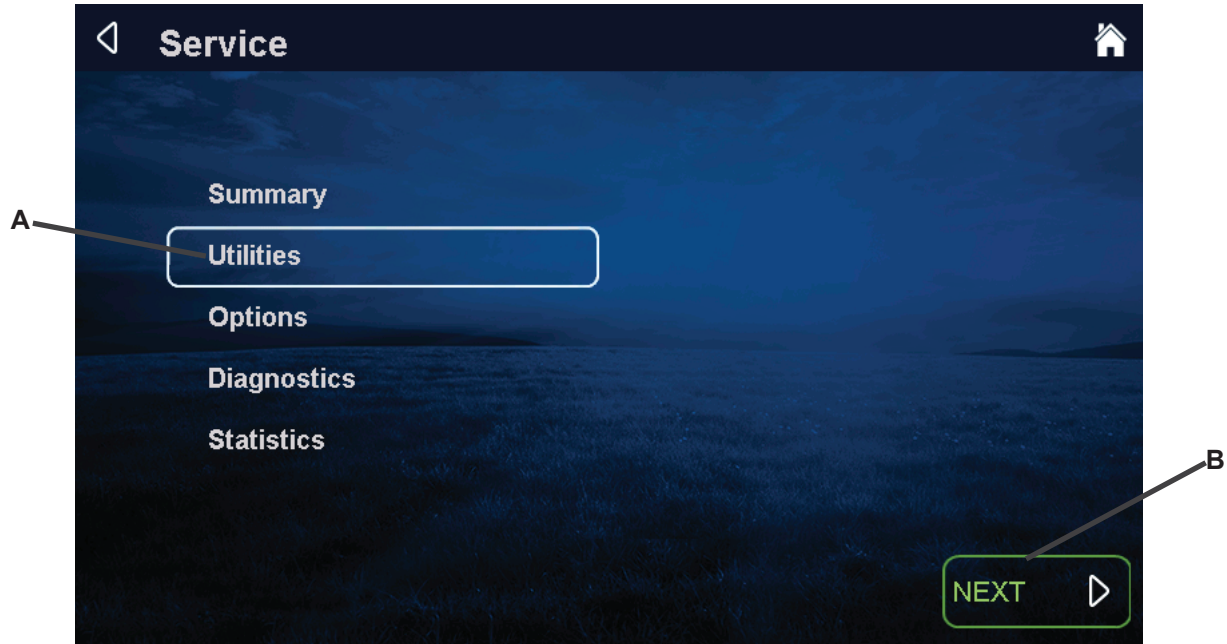

3. Under Utilities select **Product Setup** (A). Press **NEXT** (B) to continue.

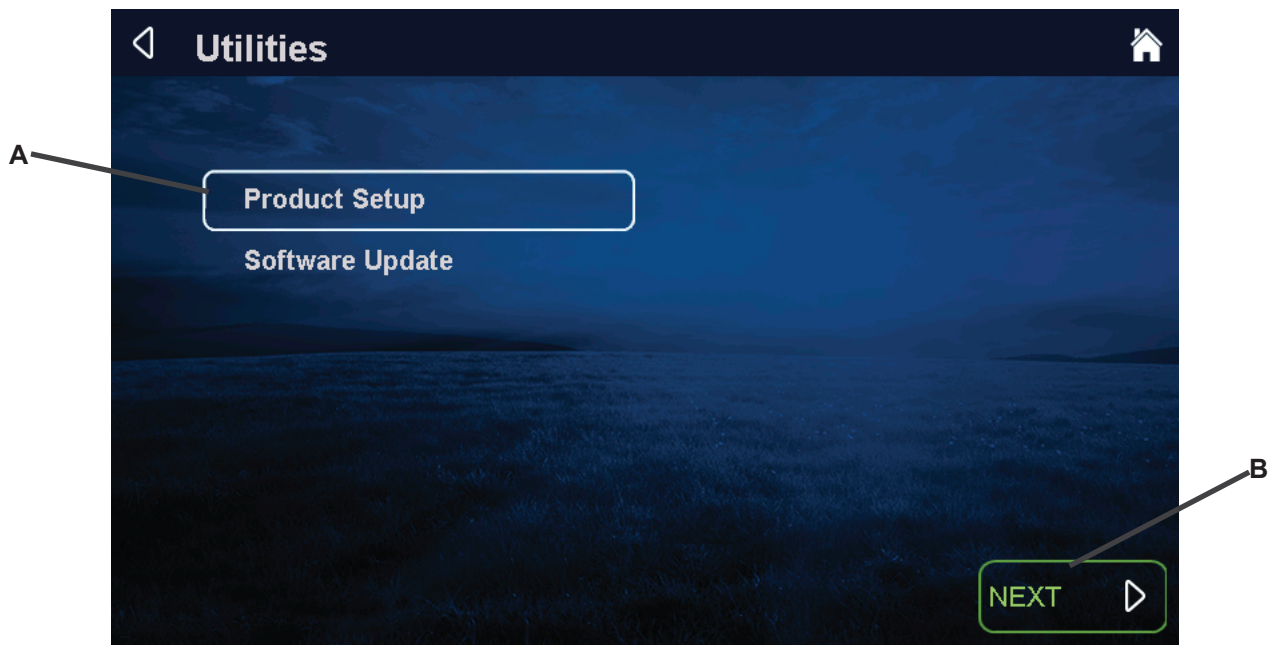

STEP 3—CALIBRATE THE TREADMILL CONTINUED

4. To configure the treadmill, press **Setup Wizard** (A).
5. In the Setup Wizard, select the correct base model and follow the on-screen instructions to complete the procedure.

NOTE: Misconfiguration of the console may cause damage to the unit and void the manufacturer warranty. If necessary, please contact TRUE Technical Support at 800-883-8783 for assistance.



To enter calibration:

1. Press and hold the **TRUE** logo (A) in the upper left corner of the home screen. When the word **TRUE** (B) begins to flash, release the logo and press and hold the lower right corner of the screen (C).



STEP 3—CALIBRATE THE TREADMILL CONTINUED

2. In the Service Menu, select **Diagnostics** (A) to highlight it. Press **NEXT** (B) to continue.

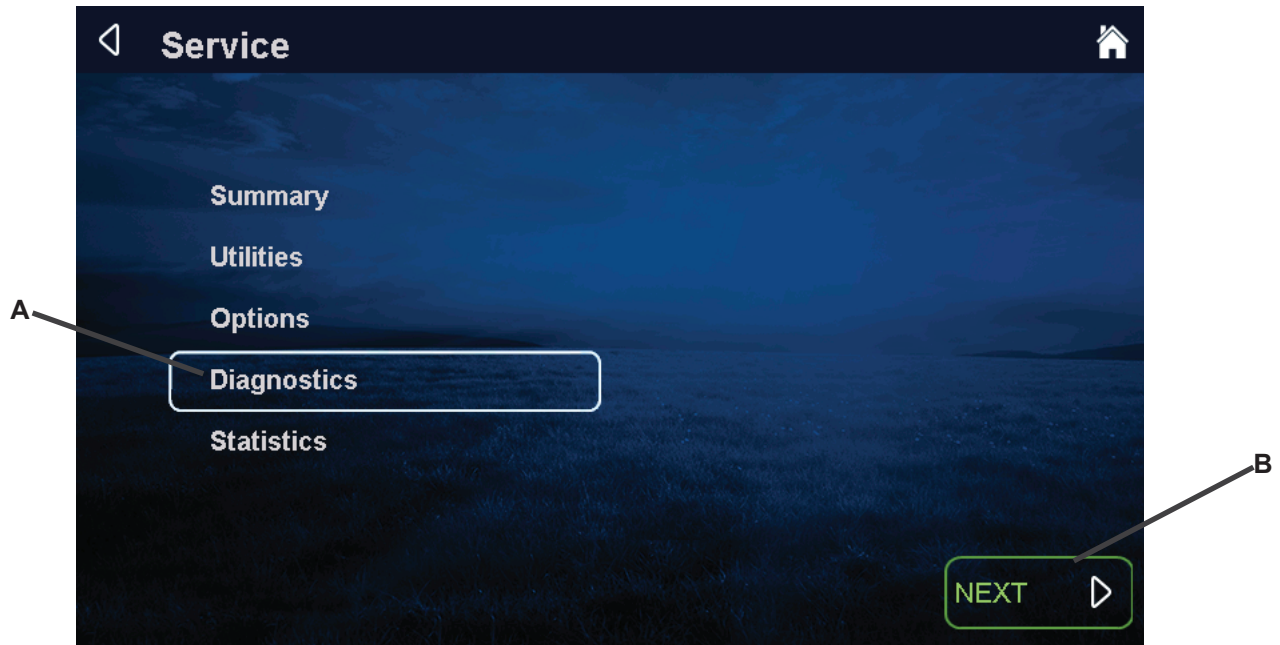

3. Under Diagnostics, select **Calibration/Test** (A) to highlight it. Press **NEXT** (B) to continue.

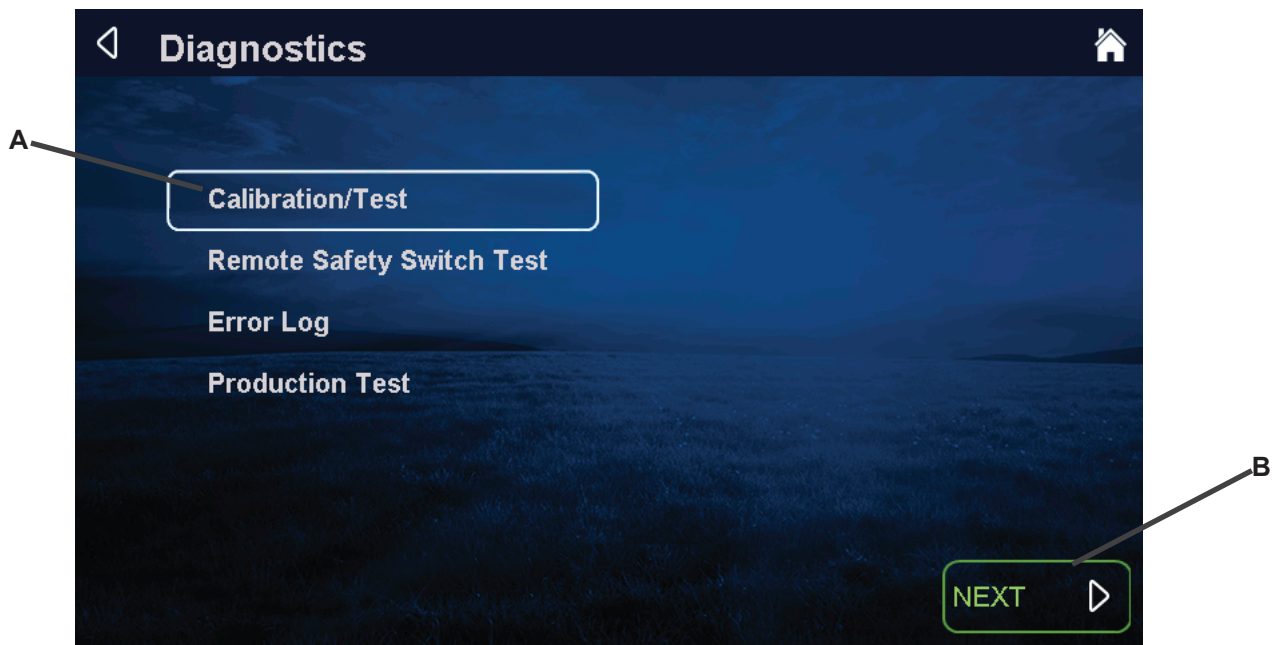

STEP 3—CALIBRATE THE TREADMILL CONTINUED

4. Under Calibration/Test, select **Speed/Incline Cal** (A) to highlight it. Press **NEXT** (B) to continue.

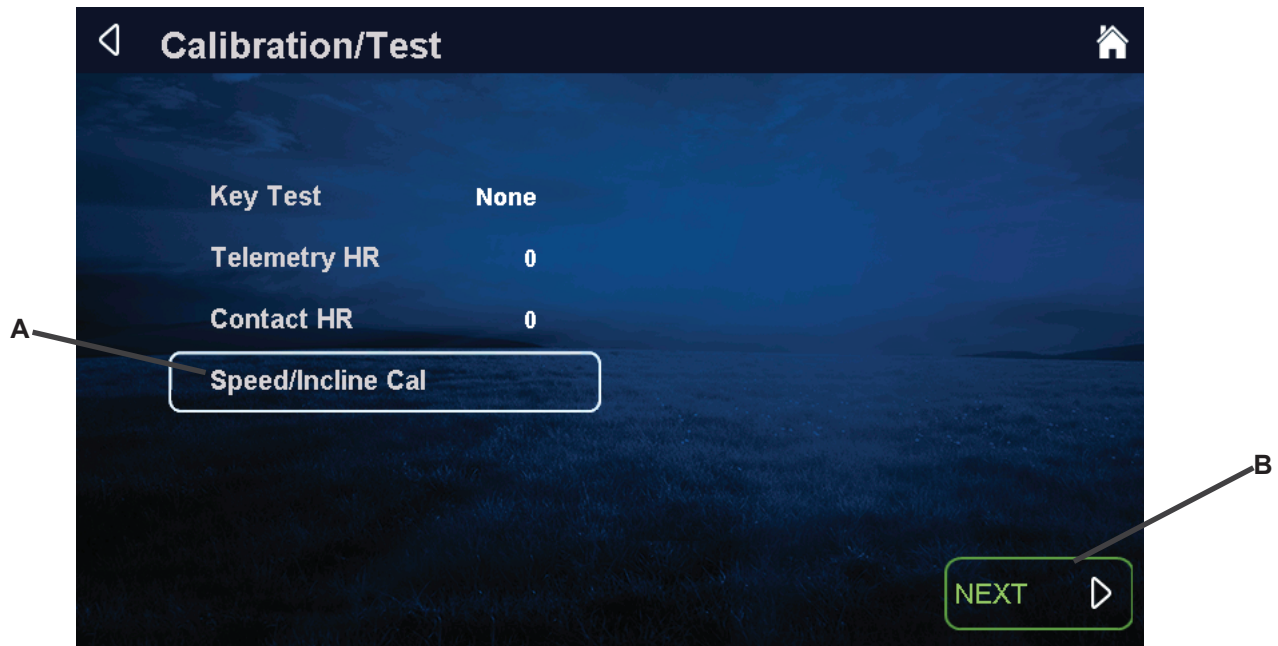

5. Under Speed/Incline Calibration, press **Run** (A) to begin calibration.
6. Once calibration is complete, turn the power off on the treadmill for 30 seconds.

⚠ WARNING: This process will take full control of the treadmill and can be dangerous if caution is not taken.

- Calibration can take up to two minutes to complete.
- Do not stand on the treadmill during the calibration procedure.
- Verify that the machine is free of all parts and tools.
- Keep children and animals at a safe distance.

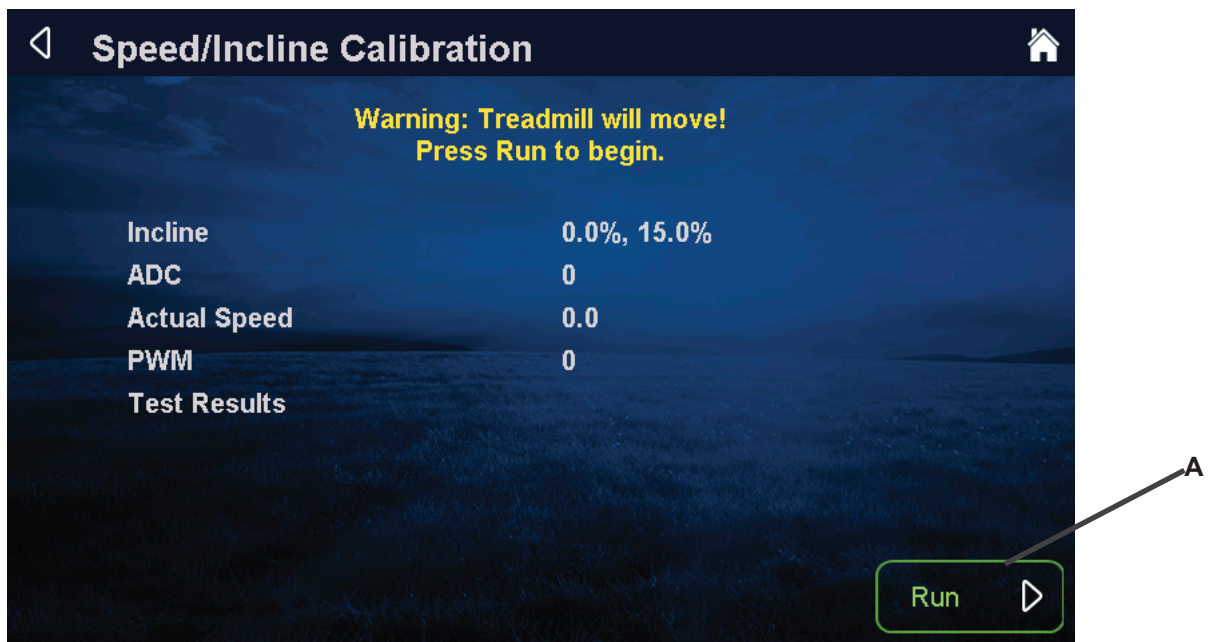

STEP 4—ATTACH REAR CONSOLE COVER

Tools Used in this Step	
#2 Phillips Screwdriver	

Part	Description	Qty
TI0076	PHCS, M4XP0.7X12	3
TPS9109	COVER, REAR CONSOLE, TPS, BLACK	1

Using a #2 Phillips screwdriver, attach the rear console cover to the console mast using 3 screws.

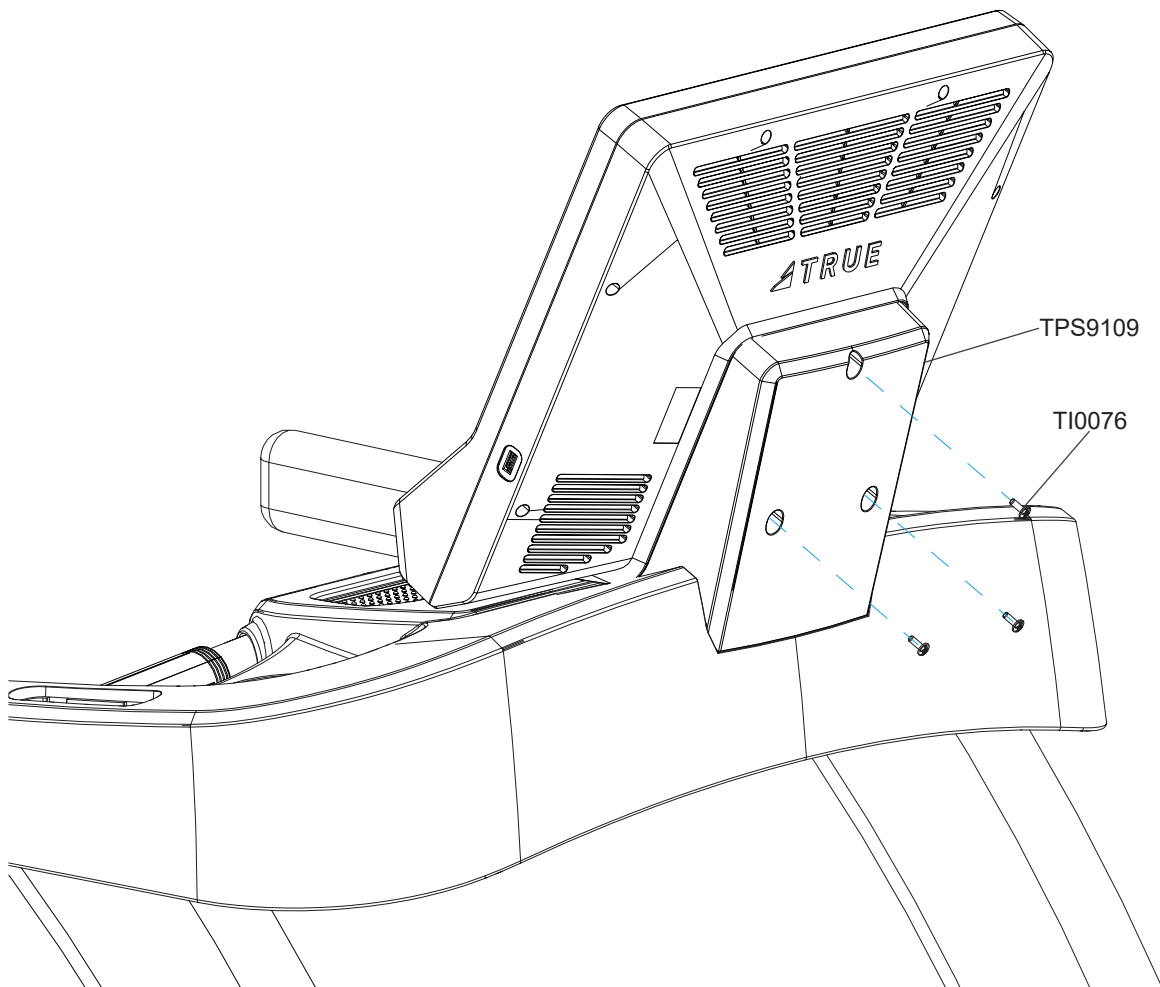

CONSOLE OVERVIEW



Touchscreen Display

A capacitive touchscreen used for workout control and feature navigation.

Quick Touch Incline Buttons

Manually increase or decrease the incline of the treadmill. Additionally, the user can set the incline percentage to preset levels of 3%, 5%, 7%, 9%, and 12%.

USB Port

Used to update console software.

Numeric Keypad

A small panel of keys on the console that allow the user to quickly enter numeric data.

Headphone Jack

Standard 3.5mm audio jack used to connect headphones to the console during media playback.

Warning Label

Important safety information for users to review prior to using the equipment.

Stop

Stops/pauses a workout. Press and hold this button for five seconds to reset the unit.

Quick Touch Speed Buttons

Manually increase or decrease the speed of the treadmill. Additionally, the user can set the treadmill speed to preset levels of 3 mph, 4 mph, 6 mph, 7 mph, and 8 mph.

Tablet Holder

An adjustable mount designed to hold mobile devices during a workout.

Contact Heart Rate Pads

Allows the user to check their heart rate without wearing a wireless chest strap. For increased safety and accuracy this feature should only be used when the belt speed is below 4 mph.

Safety (E-Stop) Key

A tethered safety device designed to attach to both the user and the treadmill console. Removal of the key from the console will stop belt motion to prevent injury in an emergency. The safety key must be in place on the treadmill, and should be attached to the user's clothing. The treadmill will not operate if the safety key is not attached to the treadmill.

PROGRAMMING AND OPERATION

TOUCHSCREEN INTRODUCTION

The touchscreen console utilizes a fully integrated capacitive touch screen display and a multi-screen interface to provide a state of the art and user friendly workout.







Capacitive touchscreen technology relies on the conductive properties of the human body to detect when and where on the display the user is touching. Because of this, capacitive touchscreens are highly responsive and do not require pressure to register a touch.

TOUCHSCREEN NAVIGATION

TRUE recommends that users familiarize themselves with the different screens to ensure that they are safely taking advantage of all of the features that this equipment has to offer.

Icon Character Map

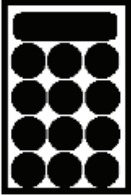
This console uses several icons to provide users with a simplified and visually appealing workout experience. The character map below is a quick reference of commonly used icons.

 <p>Incline</p>	 <p>Speed</p>
 <p>Cool Down</p>	 <p>Toolbox</p>
 <p>Home</p>	 <p>Keypad</p>
 <p>Screen Toggle</p>	

⚠ CAUTION: The safety key must be in place on the treadmill console, and should be attached to the user's clothing. The treadmill will not operate if the safety key is not attached to the console.

HEART RATE MONITORING

This treadmill can monitor a user's heart rate using a Polar* 5kHz compatible chest strap, a Bluetooth heart rate transmitter or the metal grips on the hand rails (called contact heart rate or CHR pads). Bluetooth transmitters and chest straps transmit the user's heart rate to the treadmill via radio, and the CHR pads connect to a special computer circuit to extract the user's heart rate.

Chest Strap and Bluetooth Heart Rate Monitoring

Although this treadmill functions fine without using the heart rate monitoring feature, this kind of monitoring gives valuable feedback on the user's effort level. Using chest strap or Bluetooth monitoring also allows users to use Heart Rate Control, the most advanced exercise control system available. When users wear a Polar® compatible transmitter strap or a Bluetooth transmitter, the treadmill will display the user's heart rate as a digital beats-per-minute (bpm) readout. A chest strap should be worn directly against the user's skin, about 1-2 inches below the pectoral muscles/breast line. Women should be careful to place the transmitter below their bra line. *Bluetooth transmitters should be worn in accordance with the manufacturer's documentation. Initially the transmission signal for heart rate may be erratic or non-existent. Some moisture is necessary between the strap and the user's skin for proper transmission. Sweat from exercise works best, but ordinary tap water may be used prior to the workout if desired.

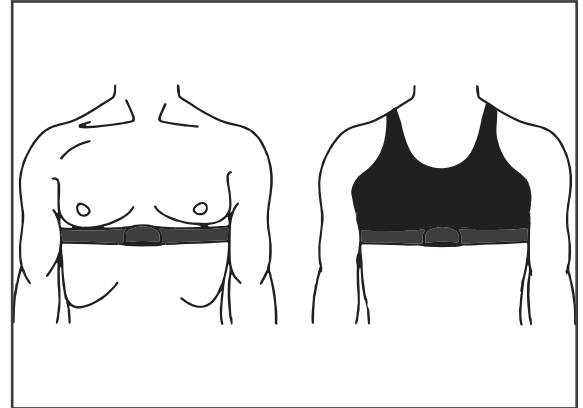

NOTE: The chest strap produces a radio signal that the treadmill reads and registers as the user's heart rate. The accuracy of a reading may be affected when outside interference is present.

Contact Heart Rate (CHR)

The CHR system will let the user monitor their heart rate without wearing a chest strap. When using the CHR system users should gently grasp the CHR pads with both hands. Within 30 seconds, the user's heart rate should be displayed as a digital bpm readout (during the first 30 seconds the system is analyzing and locking in the user's heart rate). Users should exercise with smooth body motions and breathe regularly. It is best to avoid talking while using the CHR system, as talking will cause unrepresentative heart rate spikes of 5 to 10 bpm. To ensure an accurate reading, the user's hands should be clean, free of both dirt and hand lotions.

NOTE: For increased safety and accuracy the CHR system should only be used at speeds of 4 mph or lower (CHR readings are less accurate due to large muscle movements above this speed).

NOTE: CHR monitoring may be less accurate than chest strap monitoring since the heart rate signals are much stronger at the chest. When using a HRC workout, it is best to use a chest strap because of the stronger and more accurate readings. Do not use the contact heart rate grips as a handlebar during a workout.

⚠ CAUTION: Do not use the contact heart rate grips as a handlebar during a workout.

HEART RATE CONTROL (HRC)

You are now the owner of the most sophisticated Heart Rate Control (HRC) treadmill available. TRUE HRC is unique and patented. It accommodates users from rehabilitation to world class athletes, and all those in between. TRUE HRC allows users to do a completely hands-free heart rate controlled workout using speed, incline or both. By training at a specific target heart rate, users can exercise at a more efficient cardiovascular level.

The TRUE HRC system is unique because users must enter the key parameters of the workout; target heart rate, maximum speed, maximum incline, and time, prior to beginning the HRC workout. As users approach their target heart rate, the treadmill's computer automatically takes over and changes the speed and/or incline automatically to keep users near their target heart rate. This allows for a completely "hands-free" workout.

NOTE: A Bluetooth or Polar® compatible heart rate monitoring chest strap should be worn during HRC workouts. For increased safety and accuracy, contact heart rate monitoring is not recommended for HRC workouts.

Target Heart Rate

TRUE's Heart Rate Control (HRC) workouts let the treadmill monitor relative exercise intensity by way of the user's heart rate, then automatically adjust the speed and incline to keep the user at their target heart rate and thus their desired exercise intensity. Heart rate is a good measure of the body's exercise stress level. It reflects differences in physical condition, fatigue, the comfort of the workout environment, even diet and emotional state. Users should compare their heart rate with how they feel to ensure safety and comfort.

Consult a Physician to Determine Heart Rate

Using heart rate to control a workout takes the guesswork out of the workout settings. Consult a physician before using heart rate controlled workouts for advice on selecting a target heart rate range. Also, it is important to use the treadmill for several workouts in the manual mode while monitoring heart rate. Users should compare their heart rate with how they feel to ensure safety and comfort. After users have spent some time learning how their heart responds to different levels of speed and incline, they will have a better understanding of how to select the maximum speed and maximum incline required for reaching their target heart rate.

Warm Up

At the beginning of an HRC workout, the treadmill is in full Manual Control mode. Users should gradually increase the workout intensity to slowly raise their heart rate to within 10 beats per minute (bpm) of their target heart rate. The treadmill will operate as if in manual mode during the warm up stage. Users control both speed and incline. The user may only increase speed and incline to the present maximum values entered. It is important that the user starts at a low level of perceived exertion and gradually increase the workout intensity over several minutes until they approach their target heart rate. This allows the body to adapt to the workout. Increasing the workout intensity gradually will allow the user to enter the Heart Rate Control stage without overshooting their target, keeping their heart rate within a few bpm of their target.

NOTE: Warming up too fast may cause the user to overshoot their target. If this occurs it may take several minutes before the computer software can control their heart rate. Users may overshoot and undershoot for several minutes until control is achieved.

Heart Rate Control Stage

The treadmill takes control of speed and incline, keeping the user's heart rate within a few bpm of their target. When using the Interval HRC Workout, the treadmill alternates between work and rest intervals.

Cool Down

At the end of the workout time or distance, the treadmill reduces the workout intensity by half and goes back into Manual Control mode, where users directly control their cooldown.

PROGRAM DESCRIPTIONS

Quick Start

A workout in which the user controls all settings. The workout continues until it is ended by the user.

Manual

Users enter their weight, workout time or distance. The user controls both the SPEED and INCLINE of the treadmill throughout the workout.

Hill Intervals

Hill Intervals are in two minute segments with the speed remaining constant. Speed changes are permanent; incline changes affect the current two minute segment only.

Rolling Hills

A series of gradually increasing and decreasing incline changes that simulate rolling hills.

Single Hill

Incline increases to a maximum at the mid-point of the workout, then decreases to the finish. Incline changes affect the current segment only. Speed changes are permanent.

Weight Loss Hills

Two minute walking interval segments with incline alternating between hills and a nearly flat landscape. Speed changes are permanent; Incline changes affect the current segment only.

Glute Buster

A changing incline profile focuses on intense glute muscle use.

Calorie Goal

This workout allows users to choose a speed, incline and workout time combination that will achieve their calorie goal.

Walk and Run Intervals

Walking then running intervals in one minute segments. Incline changes are permanent; speed changes affect the current segment only.

Speed Intervals

Zero-incline speed intervals in one minute segments. Any incline changes are permanent while speed changes during the workout affect the current segment only.

Speed Ramp

Speed increases to a maximum at the mid-point of the workout, then decreases to the finish. Speed changes affect the current segment only. Incline changes are permanent.

Leg Shaper

A workout with speed changes to work the leg muscles with added intensity.

PROGRAM DESCRIPTIONS CONTINUED

Cardio Challenge

Speed and incline increase to a maximum at the mid-point of the workout, then decrease to the finish. Incline and speed changes affect the current segment only.

Target HRC

Users choose their target heart rate. The treadmill begins in MANUAL control – The user should gradually increase the workout intensity until heart rate is within 10 bpm of their target. At this point, the treadmill takes over to control speed and incline to maintain heart rate within a few beats of the user's target.

Weight Loss HRC

Based on age, this is a heart rate controlled workout at 65% of the user's maximum heart rate. This creates efficient fat burning without overstraining. The treadmill begins in MANUAL control –The user should gradually increase the workout intensity until their heart rate is within 10 bpm of their target. At this point, the treadmill takes over to control speed and incline to maintain heart rate within a few beats of the user's target.

Aerobic HRC

Based on age, this is a heart rate controlled workout at 80% of the user's maximum heart rate. This keeps the user in the optimum aerobic training range to improve cardio fitness. The treadmill begins in MANUAL control - gradually increase the workout intensity until the user's heart rate is within 10 bpm of their target. At this point, the treadmill takes over to control speed and incline to maintain heart rate within a few beats of the user's target.

Intervals HRC

Intervals of work and rest determined by target heart rate. The treadmill begins in MANUAL control – Users should gradually increase their workout intensity until their heart rate is within 10 bpm of their target. At this point, the treadmill takes over to control speed and incline to maintain the user's HR within a few beats of their target. The rest segment will reduce to 65% intensity of work segment.

5K Workout

A popular distance run. Users choose their speed and the workout will end at 5 kilometers (3.1 miles).

10K Workout

A challenging distance run. Users choose their speed and the workout will end at 10 kilometers (6.2 miles).

Half Marathon

A very challenging distance run. Users choose their speed and the workout will end at 21 kilometers (13.1 miles).

Gerkin Fitness Test

A fitness test uses heart rate to estimate the user's VO2 max. The test increases speed and incline gradually every minute and ends at the point where the user's heart rate reaches 85% of the maximum for their age.

Custom Ultra

This completely customizable workout setup allows both speed and incline control in up to 30 segments.

Saved Workouts

Access to previously saved manual workouts.

TOUCHSCREEN CONSOLE

CONSOLE NAVIGATION

Home Screen

The Home Screen is displayed on the console when there is no workout in progress. From this screen the user is able to select from various options to begin a workout.



A. Quick Start

Starts a Quick Start workout in which the user controls all settings until the workout is ended by the user.

B. User Profiles

Custom profiles used to store a user's age, weight, and saved workouts.

C. Last 10 Workouts

Displays the last 10 workouts that were completed on the treadmill and allows users to easily replay a recent workout.

D. New User

Creates a new User Profile.

E. Workout Finder

Displays a list of the preprogrammed workouts that are available on this treadmill.

F. Bluetooth

Allows users to pair their Bluetooth devices prior to beginning a workout.

CONSOLE NAVIGATION CONTINUED

Selecting a Preset Workout

Preset workouts are accessed by selecting **WORKOUT FINDER** from the Home Screen. To view the description of a workout (A), select the workout by touching it (B). Once the desired workout has been selected, simply press **NEXT** (C) to proceed.

NOTE: Workouts can be viewed by category by pressing **i** (D).

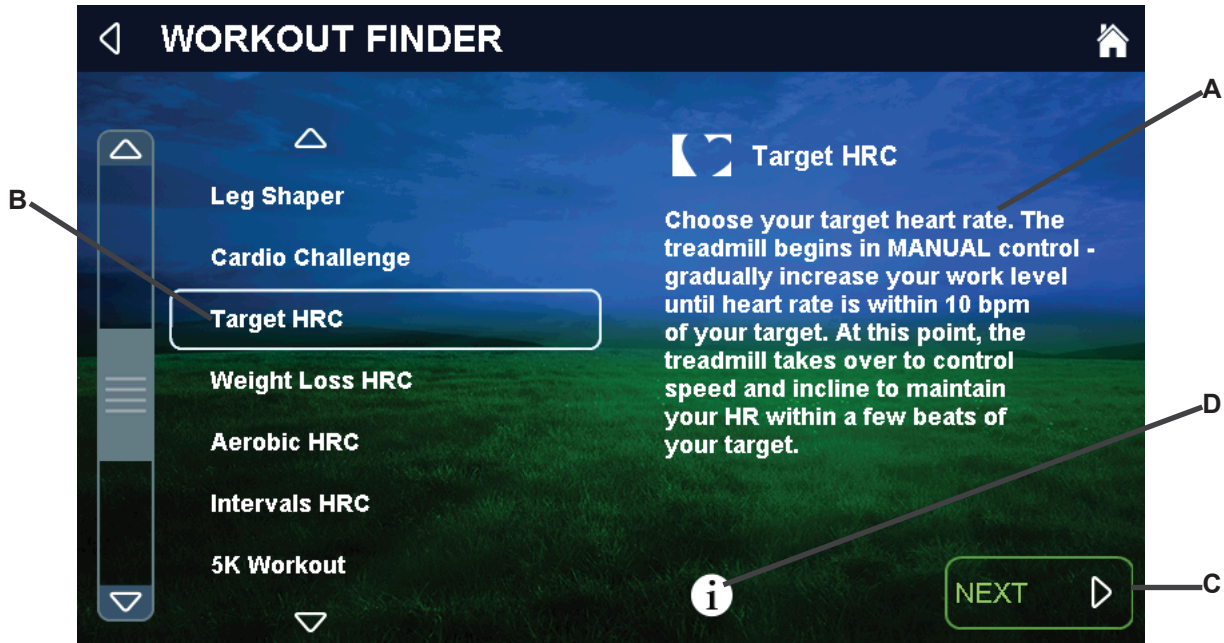

Workout Data Entry Screens

These screens allow users to input their personal information or workout goals prior to beginning a workout. To set a value, touch the value to be changed (A) and use the **KEYPAD** (B) or the **+ and - speed** buttons to adjust the value to the desired setting. Once all values are set, touch **START** (C) to begin the workout or **SAVE?** (D) to save the workout to a user profile.

NOTE: Workout Data Entry Screens vary by program selection.



CONSOLE NAVIGATION CONTINUED

Workout Data Screens

During any workout a Workout Data Screen will be displayed to give the user a comprehensive visual overview of their current workout data.

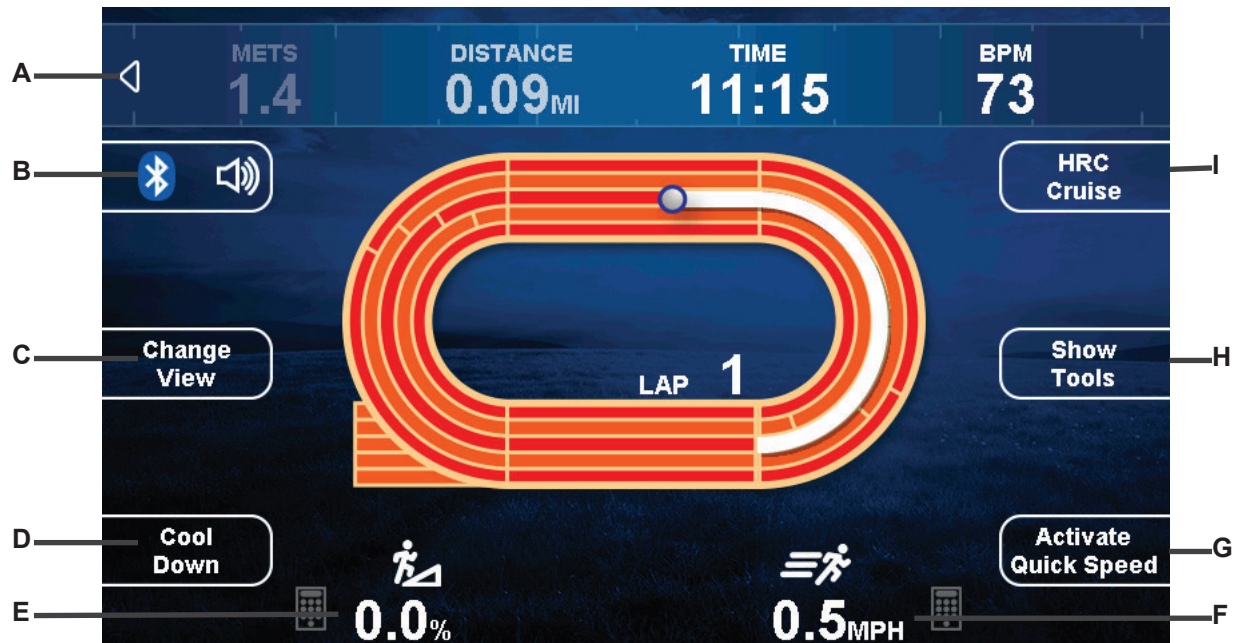

A. Statistics Bar

Displays data such as Calories, METS, Distance, Time and Heart Rate during a workout. This may be hidden by touching the arrow on the left side of the bar.

B. Bluetooth

Enables or disables the Bluetooth audio function.

C. Change View

Switches between the available Workout Data Screens.

D. Cool Down

Allows the user to end their current workout with a two minute low intensity cooldown period. When Cool Down is activated the unit is in manual mode and the user directly controls all settings.

E. Incline

Displays the current level of incline. The incline level can be changed by pressing the keypad icon and entering a numeric value.

F. Speed

Displays the current treadmill speed. The speed can be changed by pressing the keypad icon and entering a numeric value.

G. Quick Touch

Displays various preset speeds and incline levels to allow the user to quickly and conveniently customize their workout.

H. Show Tools

Gives the user the following options:

- Customize the data shown in the Statistics bar.
- Change units between English and Metric.
- Pair a Bluetooth heart rate strap.

I. HRC Cruise

Engages Heart Rate Control to allow the equipment to maintain the user's current heart rate through automatic speed and incline adjustments (when the user is utilizing heart rate monitoring).

USER PROFILES

Creating a New User

To create a new user profile, touch **NEW USER** on the Home Screen and the **NEW USER** screen will appear. Tap the information (A) on the left side of the screen to edit it. Once all of the information is complete, touch **BACK** (B) to return to the home screen.

NOTE: The number of user profiles is limited to six.

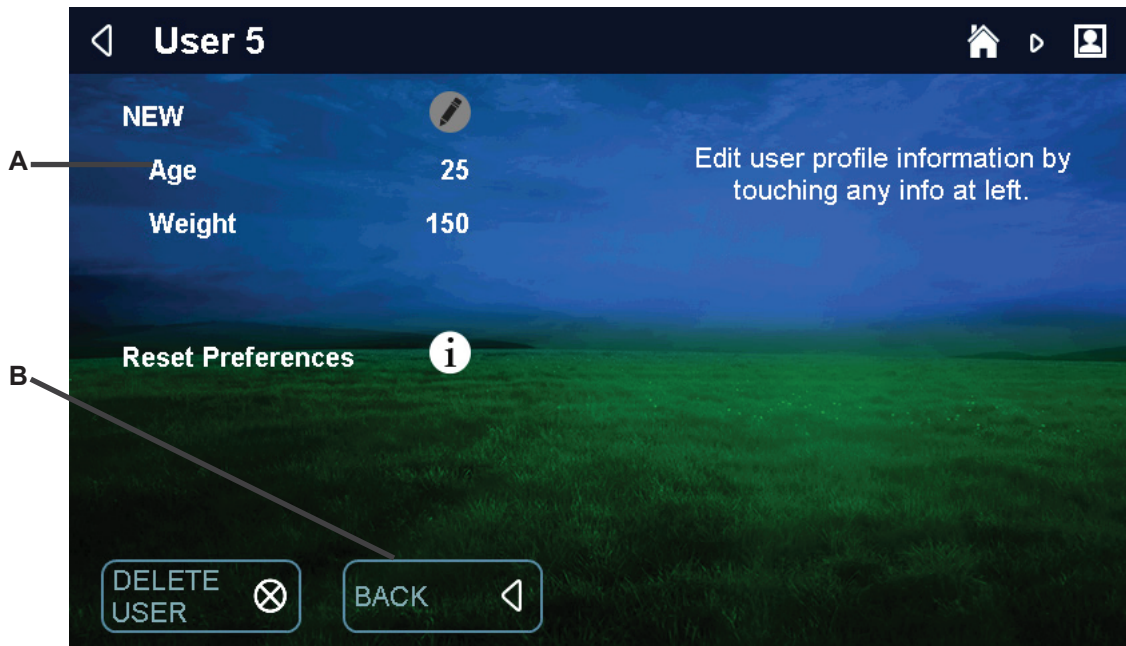

Beginning a Workout

Tap the desired user profile on the Home Screen to display the User Profile. From this screen the user can replay their last workout by touching **START** (A), replay a saved workout by touching **SAVED WORKOUTS** (B) or find a new workout by touching the **WORKOUT FINDER** (C).

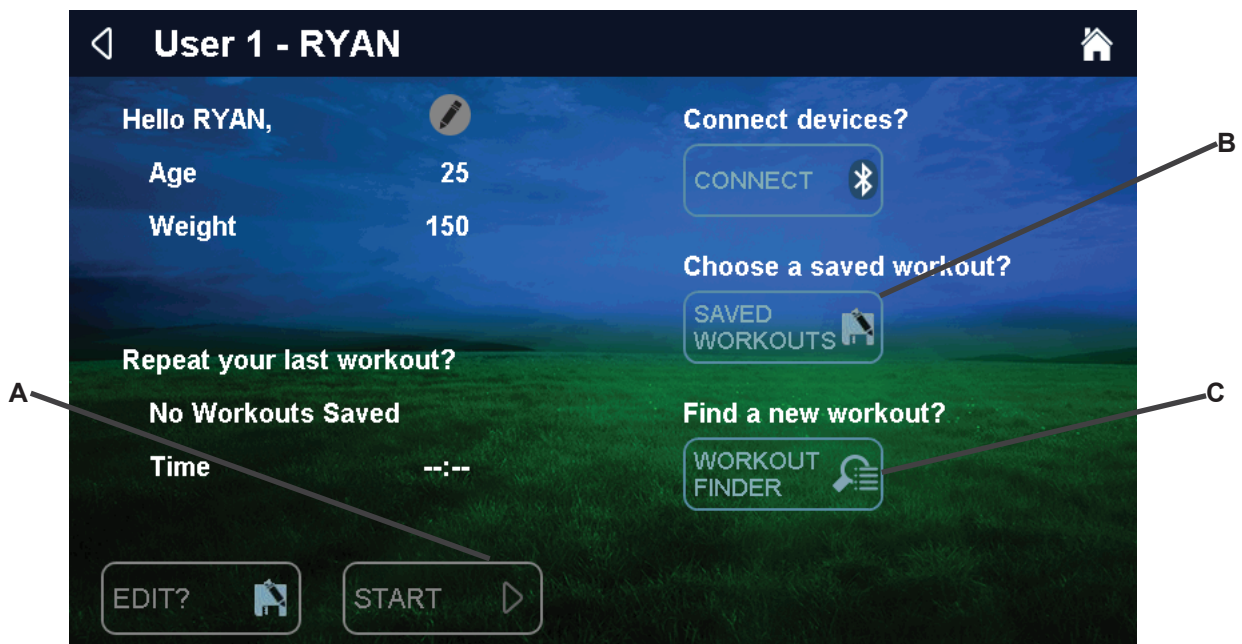

BLUETOOTH FUNCTIONS

Bluetooth Audio (Before Workout)

Tap **Bluetooth** on the Home Screen or in a User Profile to display the CONNECTIVITY screen. Touch **PAIR** (A) on the console to begin the pairing process. From the Bluetooth menu on your audio device, select the device listed on the console (B) to complete the pairing process.

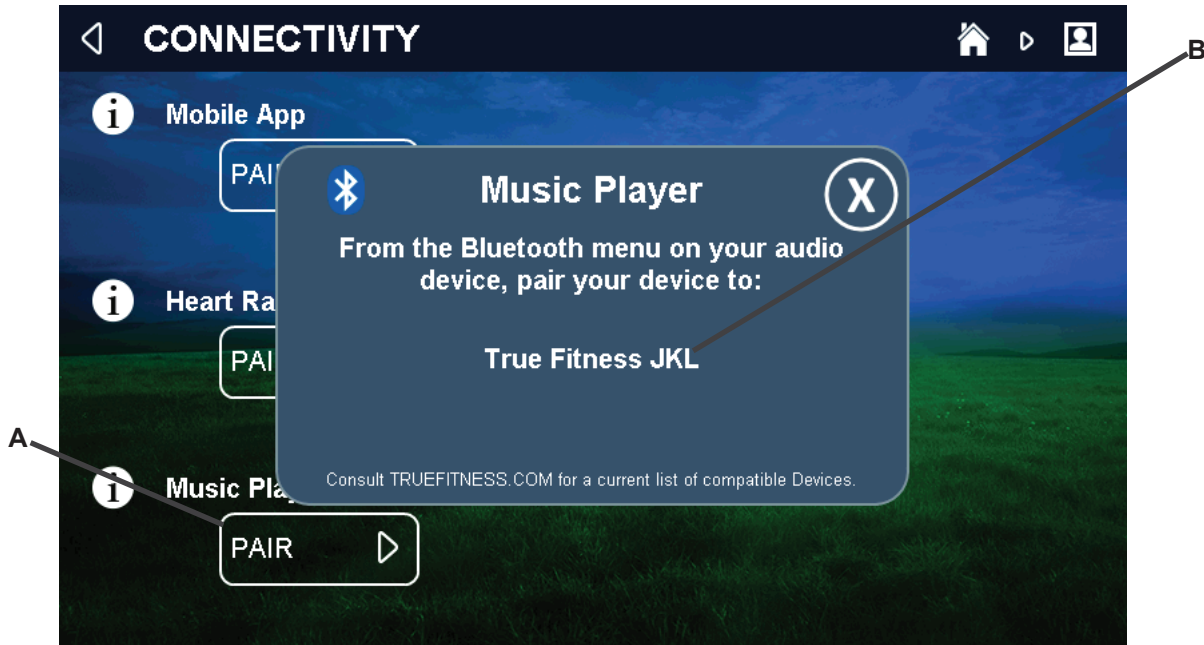

Bluetooth Audio (During Workout)

Tap **Bluetooth** (A) on the WORKOUT DATA screen to display the CONNECTIVITY screen and begin the pairing process. From the Bluetooth menu on your audio device, select the device listed on the console (B) to complete the pairing process.

NOTE: When an audio source is selected the user is given control over volume (C), and track adjustments (D).

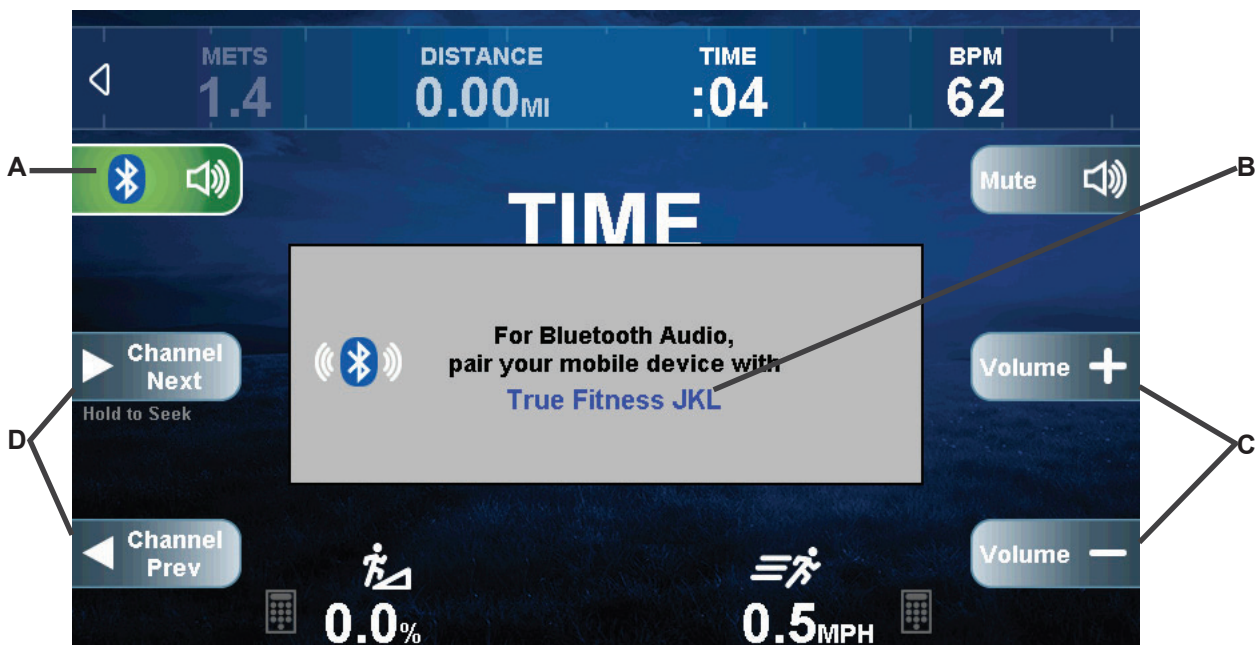

BLUETOOTH FUNCTIONS CONTINUED

Bluetooth Heart Rate (Before Workout)

Tap **Bluetooth** on the Home Screen or in a User Profile to display the CONNECTIVITY screen. Touch **Heart Rate PAIR** (A) to display the Heart Rate Pairing screen. Tap **Bluetooth HR** (B) and then select the desired device from the list provided.

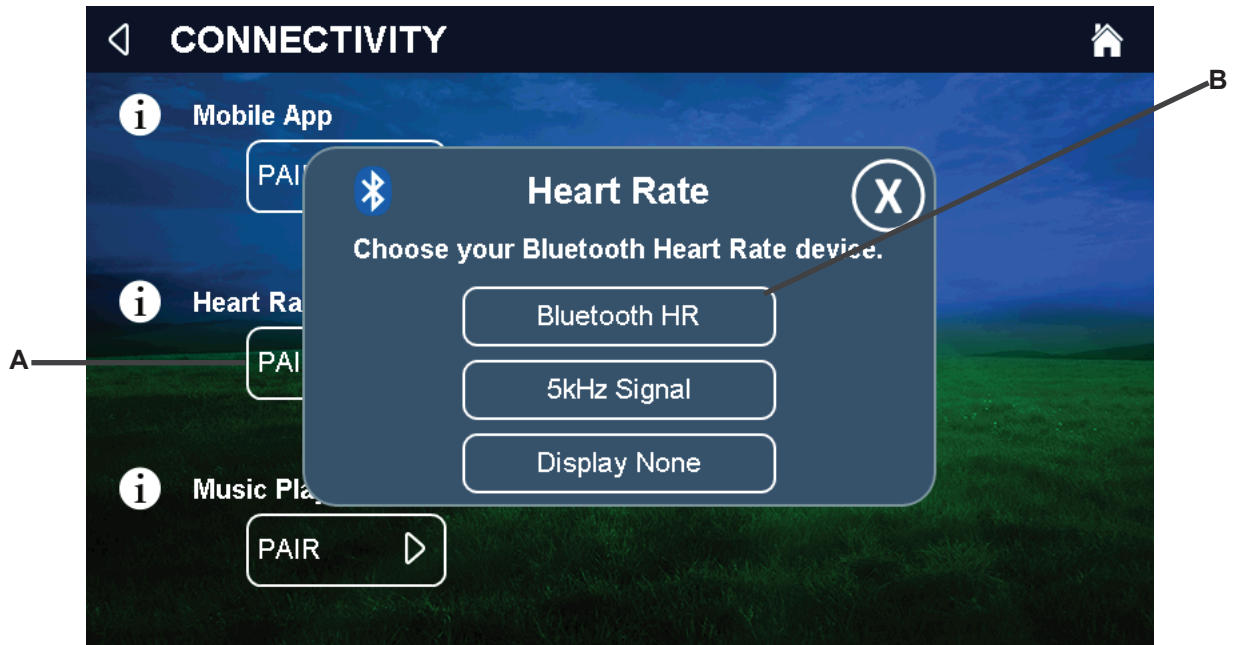

Bluetooth Heart Rate (During Workout)

To pair a Bluetooth heart rate strap, tap **SHOW TOOLS** on the Workout Data screen, then press **Bluetooth Heart Rate** (A) and select the desired strap from the list (B).

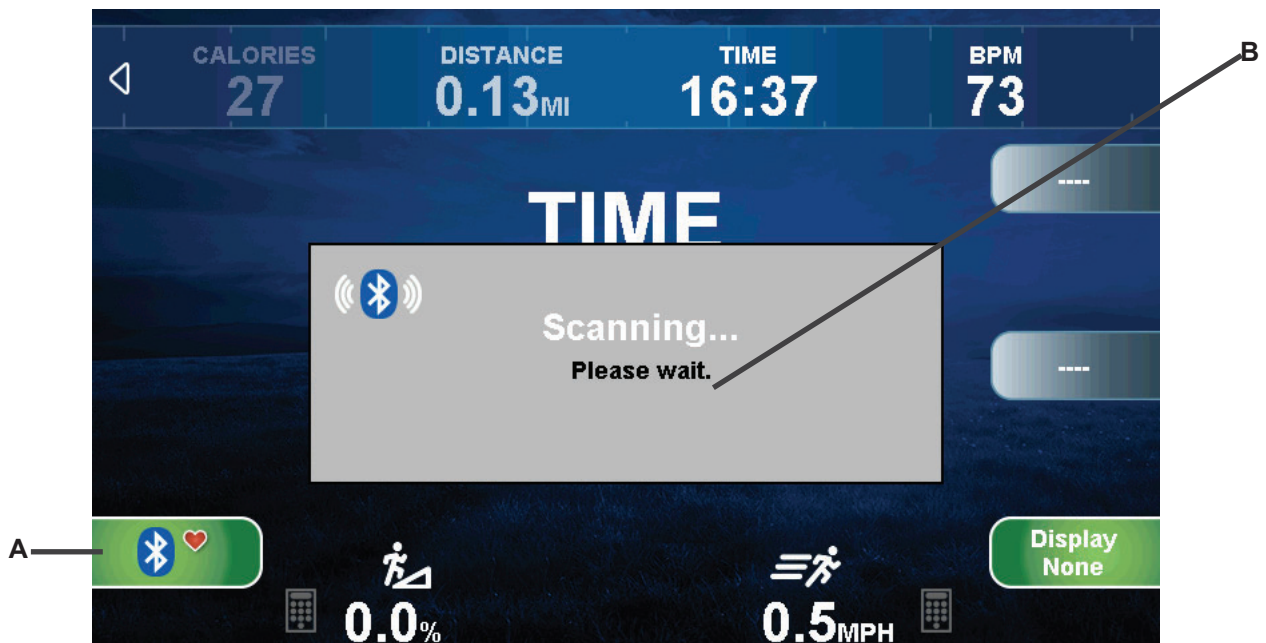

BLUETOOTH FUNCTIONS CONTINUED

Mobile Fitness App Pairing

This console is compatible with GymTrakr fitness tracking apps. To pair a compatible app, tap **Bluetooth** on the Home Screen or in a user profile to display the connectivity screen. Touch **Mobile App PAIR** (A) to display the **Mobile App Pairing** screen. From the fitness app, pair to the device (B) shown on the console.

NOTE: For additional information on compatible mobile apps, please visit www.truefitness.com

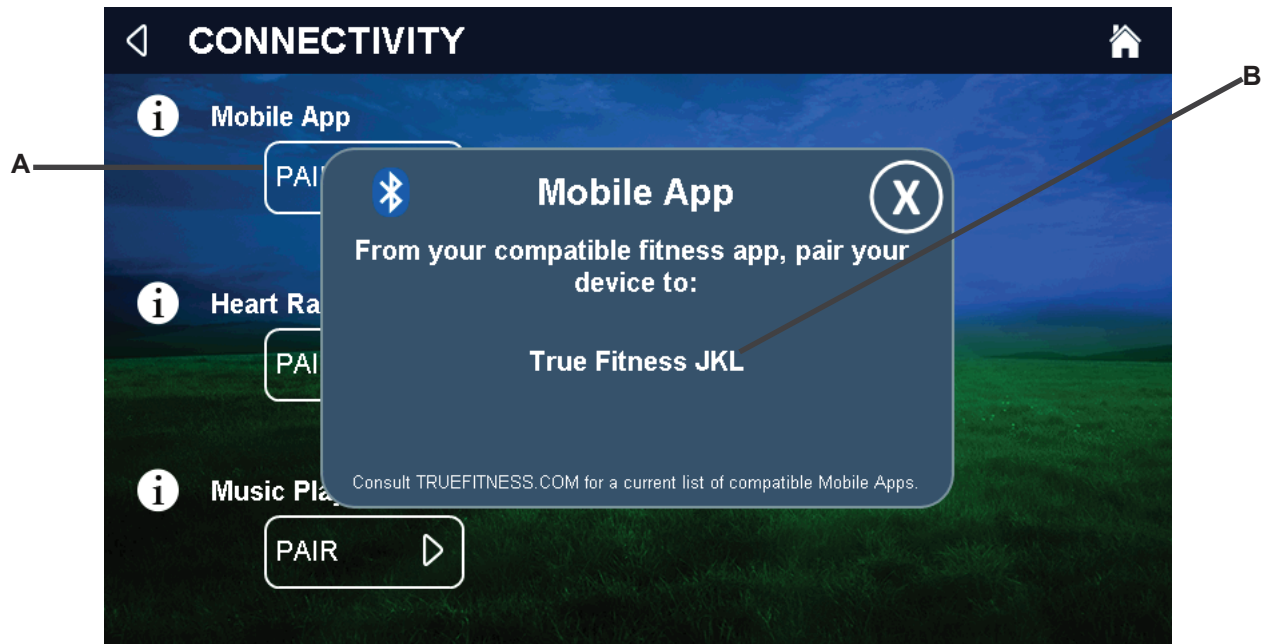

ADVANCED CONSOLE FUNCTIONS

Entering Service Mode

Press and hold the **TRUE** logo (A) in the upper left corner of the home screen. When the word **TRUE** (B) begins to flash, release the logo and press and hold the lower right corner of the screen (C).



ADVANCED CONSOLE FUNCTIONS CONTINUED

Service Menu

The first screen displayed after entering service mode is the Service menu. From this menu technicians can access all of the service mode features by selecting different categories. To select a category, touch the desired category (A) to highlight it. Once a category has been selected, press **NEXT** (B) to continue.

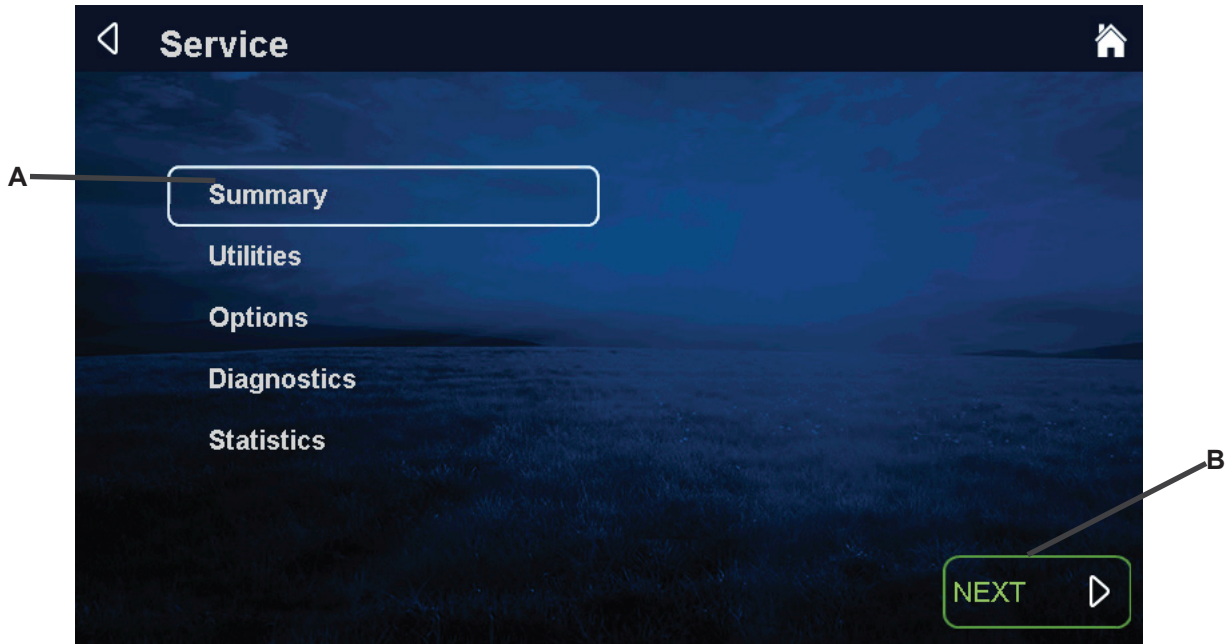

Summary Screen

The Summary screen provides an overview of the unit's current settings, including Product Model, Software Version, Units, Maximum Speed, Maximum Incline, Minimum Incline, and Maximum User Weight.

NOTE: Values cannot be changed in this screen.

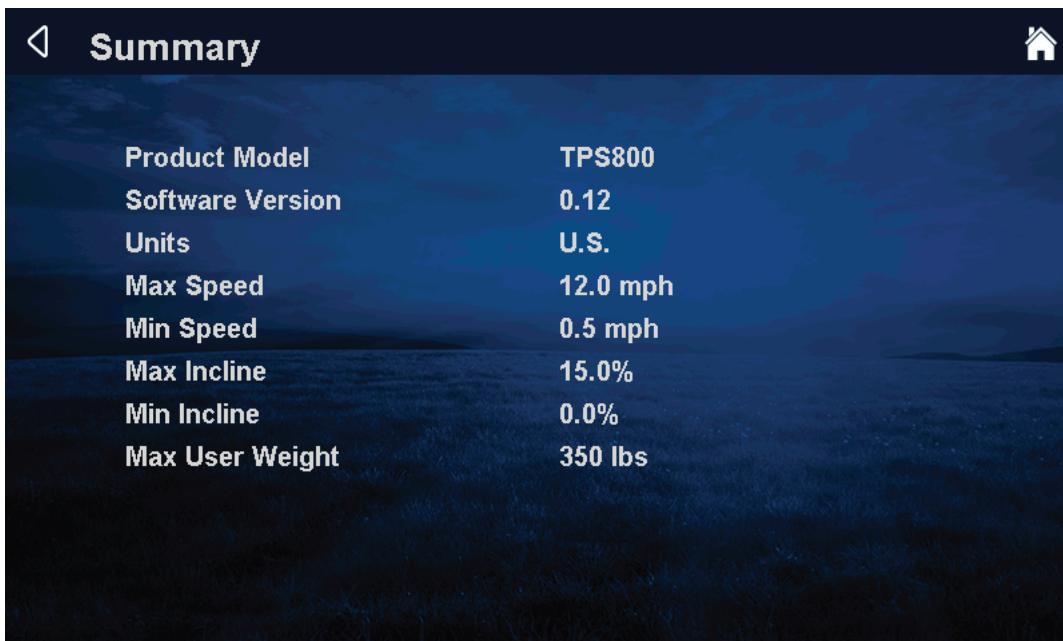

ADVANCED CONSOLE FUNCTIONS CONTINUED

Utilities Menu - Product Setup

The Product Setup screen allows the technician to adjust model configuration. To configure the treadmill, press **Setup Wizard** (A) and follow the on-screen instructions to complete the procedure.

NOTE: Misconfiguration of the console may cause damage to the unit and void the manufacturer warranty. If necessary, please contact TRUE Technical Support at 800-883-8783 for assistance.

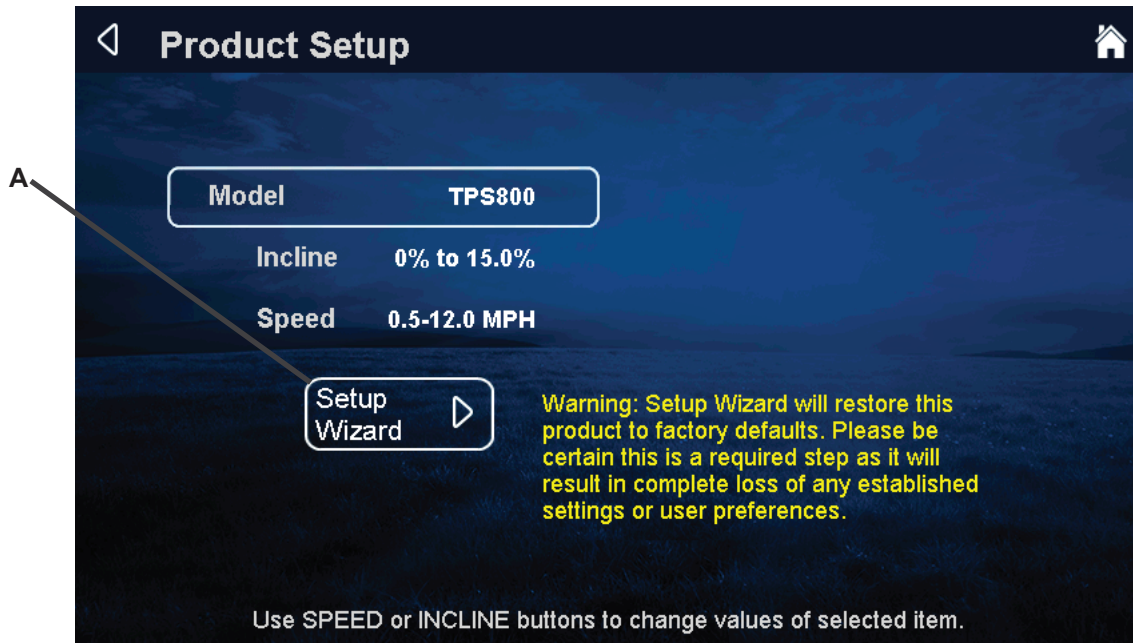

Utilities Menu - Software Update

TRUE may periodically release software updates to ensure users enjoy the best workout experience available. Due to the complex nature of this procedure, it is recommended that any software update be completed by a TRUE certified service professional.

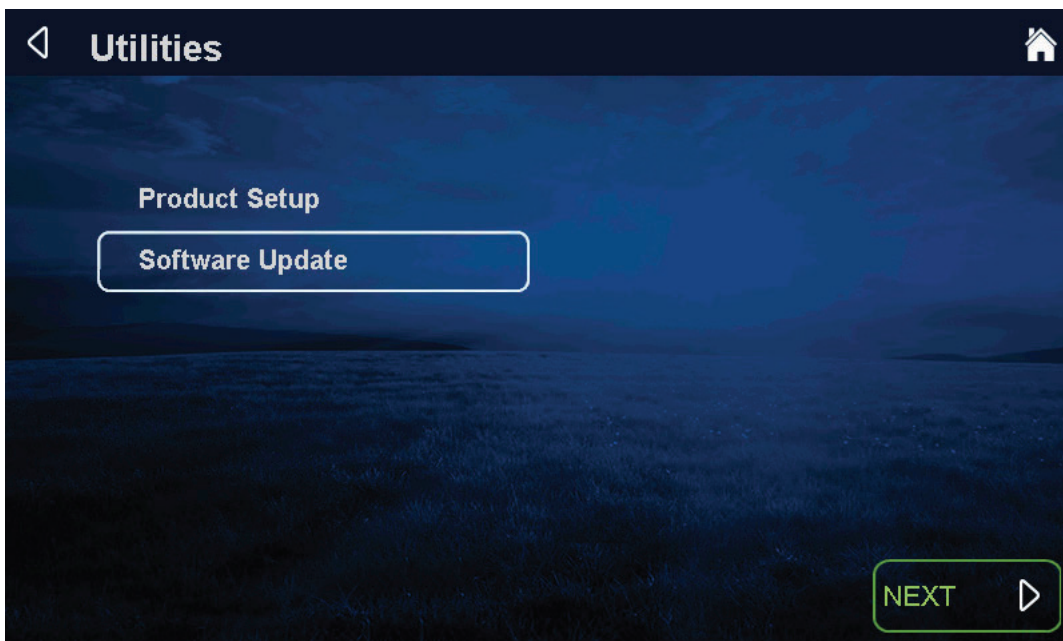

ADVANCED CONSOLE FUNCTIONS CONTINUED

Options Menu

The Options menu contains various options and settings that pertain to the operation and setup of the machine. Select the option to change and use the **+** and **- speed** buttons or **incline up** **▲** and **down** **▼** buttons to make changes.

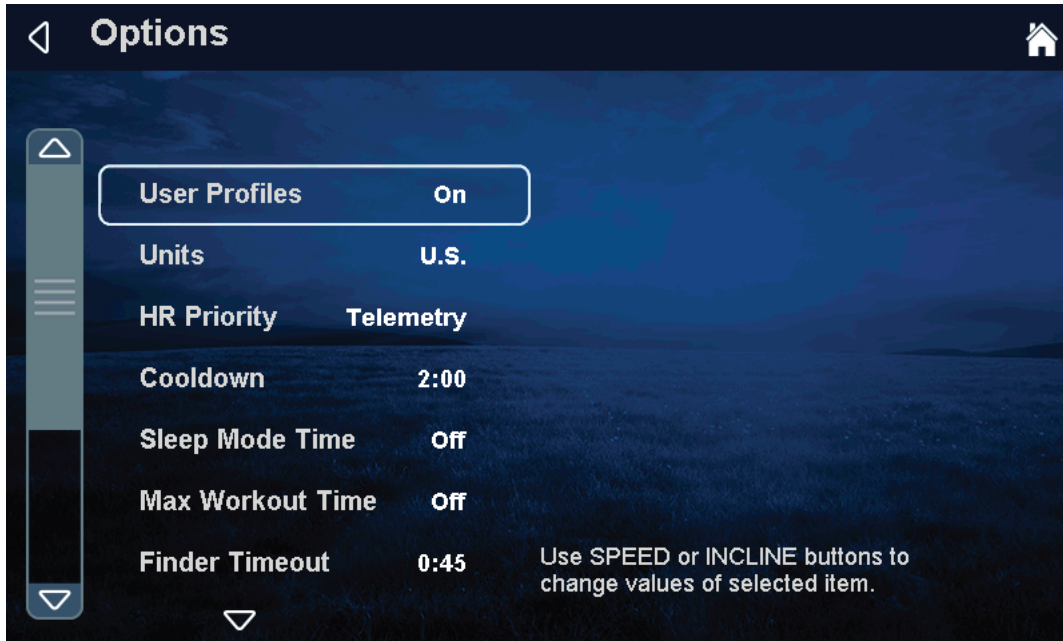

User Profiles

Enables or disables the Custom User Profile feature.

Units

Choose how the workout data is displayed by default.

HR Priority

Determines the order in which the unit reads heart rate data.

Cooldown

Adjusts the length of the cooldown time at the end of a workout.

Sleep Mode Timer

The amount of time the unit can be idle before entering Sleep Mode. By choosing the **Off** setting, the unit will remain powered.

Max Workout Time

Limits the amount of time that all workouts can last. By choosing the **Off** setting, the time will be unlimited (does not apply to manual or distance workouts).

Finder Timeout

Choose how long the Workout Finder remains on the screen without any user interaction. By choosing the **Off** setting, the workout finder will stay open until closed by a user.

Setup Timeout

Choose how long the Workout Data Entry screen will remain on the display without any user interaction. By choosing the **Off** setting, the data entry screen will be displayed until closed by a user.

Summary Timeout

Determines the amount of time the Workout Summary Screen will be displayed. By choosing the **Off** setting, the summary will be displayed until ended by a user.

Pause Time

Limits the amount of time that a workout can be paused before it automatically ends. By choosing the **Off** setting, the unit will remain paused until the user resumes or ends the workout.

Factory Defaults

Resets all settings to the factory defaults.

ADVANCED CONSOLE FUNCTIONS CONTINUED

Diagnostics Menu - Calibration/Test

This menu contains tools for testing and verifying treadmill operation.

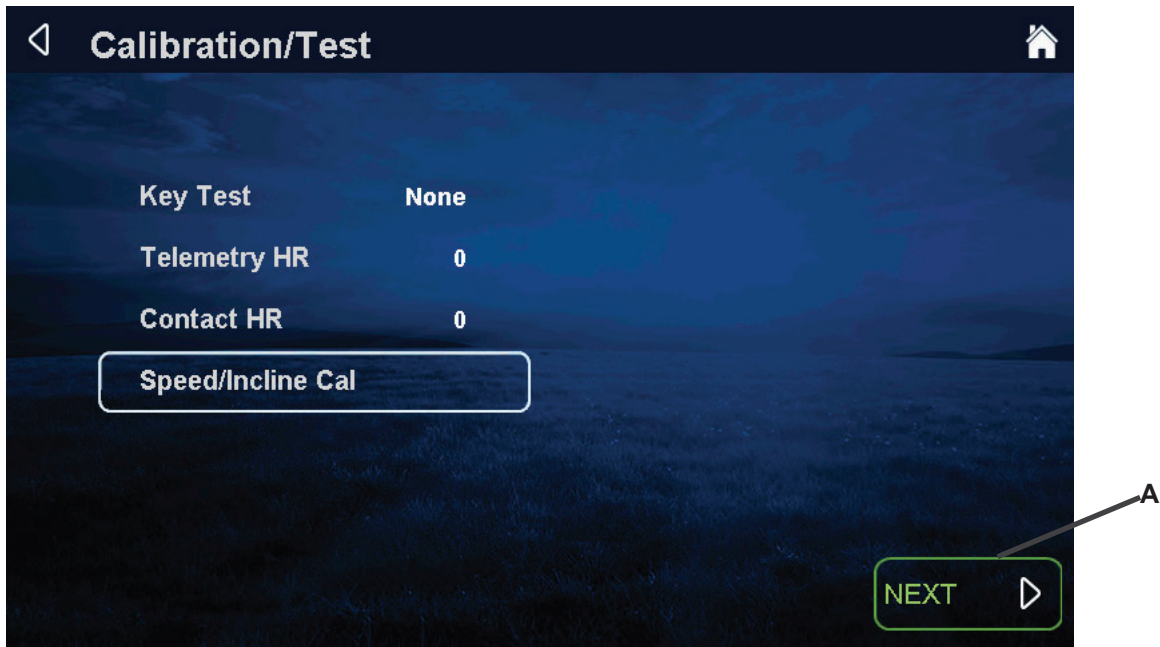

Key Test

When a key is pressed on the console **NONE** will change to indicate which key is being pressed. In the event of a stuck key, the key that is being engaged will display.

Telemetry HR

Use the supplied wireless heart rate strap or simulator to test if the unit is receiving wireless heart rate data. If there is a reading displayed without the use of a heart rate strap or simulator, there is outside interference from another source.

Contact HR

Ensures the unit is receiving the data by displaying the user's heart rate when the contact heart rate pads are gripped.

Speed/Incline Cal

Speed/Incline Cal (calibration) is selected by default in this menu. To run a calibration press **NEXT** (A) and follow the on-screen instructions.

⚠ WARNING: This process will take full control of the treadmill and can be dangerous if caution is not taken.

- Calibration can take up to two minutes to complete.
- Do not stand on the treadmill during the calibration procedure.
- Verify that the machine is free of all parts and tools.
- Keep children and animals at a safe distance.

Diagnostics Menu - Production Test

The Production Test screen is used during the production process and is not used for service or troubleshooting.

ADVANCED CONSOLE FUNCTIONS CONTINUED

Diagnostics Menu - Error Log

Error codes are an important part of troubleshooting any issues with the treadmill. Any time an error occurs it is entered into the Error Log for review by a service professional. This console is capable of storing the ten most recent errors. The error log can be cleared by pressing **NEXT** (A), but it is not recommended.

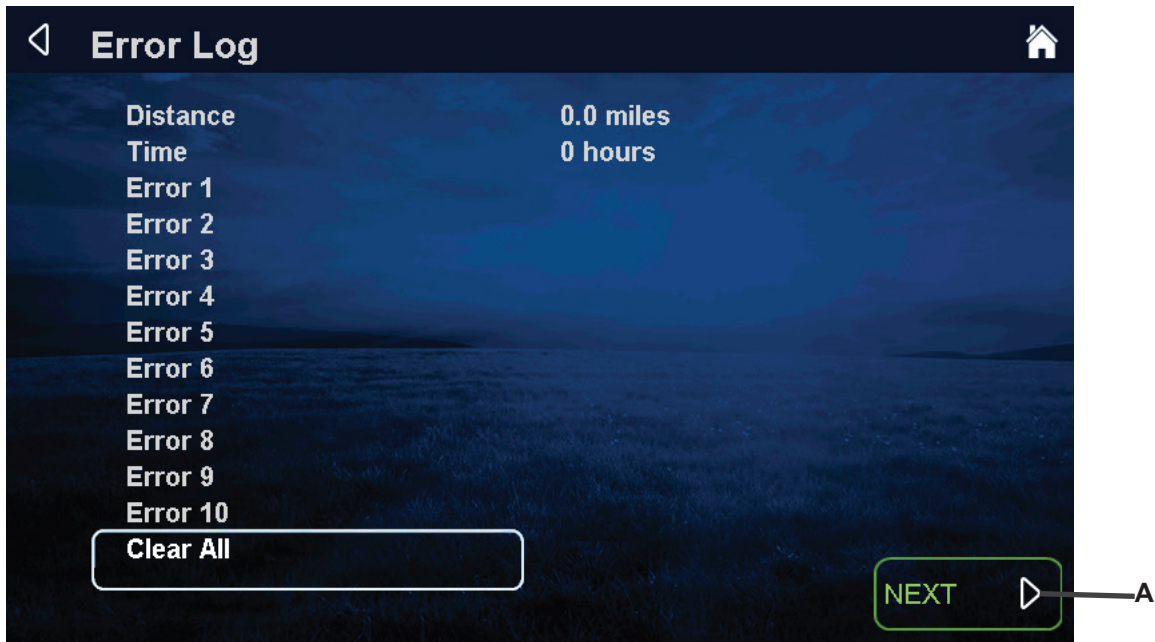

Statistics

The statistics menu displays an overview of the treadmill's running data. The overview includes Distance, Time, Average Speed, Maximum Speed, Manual Program Count, Preset Program Count, and Device Connections.



WARRANTY

NOTICE

For unit and console warranty information, refer to the Warranty Information chapter in the unit manual.

T R U E F I T N E S S . C O M



TRUE Fitness Technology, Inc | 865 Hoff Road, St. Louis, MO 63366

© 2024 TRUE. All Rights Reserved.