

C4RL LCD CONSOLE

 TRUE®



MODEL C4RL
(MAN-C4RL REV02)

**OWNER'S
MANUAL**

IMPORTANT!

All products shown are prototype. Actual product delivered may vary. Product specifications, features, and software are subject to change without notice. For the current owner's manual and documents in additional languages please visit <https://shop.truefitness.com/customer-service/user-manuals/>

IMPORTANTE!

Todos los productos mostrados son prototipos. La realidad el producto suministrado puede diferir. Especificaciones de productos, características y software están sujetas a cambios sin previo aviso. Para la más actualizada de este manual del propietario y para los documentos en otros idiomas, por favor visite <https://shop.truefitness.com/customer-service/user-manuals/>

IMPORTANT! Tous les produits présentés sont prototype. Le produit réel livré peut varier. Spécifications du produit, caractéristiques et logiciels sont sujettes à modification sans préavis. Pour la plus à jour le manuel du propriétaire et pour documents dans des langues supplémentaires, veuillez <https://shop.truefitness.com/customer-service/user-manuals/> de visite

重要提示!

显示所有产品的原型。实际交付的产品可能有所不同产品规格,功能和软件如有更改,恕不另行通知迄今为止对于大多数的使用说明书,和对于其他语言的文档,请访问<https://shop.truefitness.com/customer-service/user-manuals/>

ام اھ!

اهمى لس ت يل ع فل ا ج ت ن م ل ا ف ل ت خ ت د ق . ج ذ و م ن ل ا ي ه ق ض و ر ع م ل ا ت ا ج ت ن م ل ا ع م ج ر ا ع ش ا ن و د ر ي غ ت ل ل ق ل ب ا ق ج م ا ر ب ل ا و ت ا ز ي م ل ا و ، ج ت ن م ل ا ت ا ف ص ا و م <https://shop.truefitness.com/customer-service/user-manuals/> ق ر ا ي ز ي ج ر ي ل ك ل ا م ل ا ل ي ل د ن ا ل ا ي ت ح ل ص ي ا م م ط ع م ل <https://shop.truefitness.com/customer-service/user-manuals/> ق ر ا ي ز ي ج ر ي ، ق ي ف ا ض ا ت ا غ ل ي ف ت ا د ن ت س م ل ل

WICHTIG!

Alle hier gezeigten Produkte sind Prototypen. Das tatsächliche Produkt ausgeliefert wird, kann variieren. Produkt-Spezifikationen, Funktionen und Software können sich ohne vorherige Ankündigung ändern. In den meisten Fällen bis zu Bedienungsanleitung Bisher besuchen und für Dokumente in weiteren Sprachen finden Sie unter <https://shop.truefitness.com/customer-service/user-manuals/>

BELANGRIJK!

Alle getoonde producten zijn prototype. Daadwerkelijke product geleverd kan verschillen. Product specificaties, eigenschappen & software zijn onderhevig aan verandering zonder kennisgeving. Voor de meest actuele handleiding van de eigenaar & voor documenten in andere talen kunt u terecht op <https://shop.truefitness.com/customer-service/user-manuals/>

ВАЖНО!

Все товары указаны прототипа. Фактический продукт, поставляемый могут отличаться. Технические характеристики, особенности и программного обеспечения могут быть изменены без предварительного уведомления. Для получения самой последней на сегодняшний день руководство по эксплуатации и Для документов на другие языки, пожалуйста, посетите <https://shop.truefitness.com/customer-service/user-manuals/>

Thank You for Choosing TRUE!

Since our founding in 1981, TRUE Fitness has been guided by two core principles: Build the highest quality products and support them with superior service. Today, TRUE is the global leader in premium cardio equipment for the commercial and residential markets.

Built on decades of experience and constantly refined over time, our machines have a reputation for exceptional reliability. Our treadmills, ellipticals, and bikes face rigorous and systematic life-testing to guarantee they withstand the demands of long-term, extended use -- whether at the gym or in your home.

Thank you for becoming a part of the TRUE experience.

Contacting Our Support Team

Before you contact TRUE, we recommend gathering the serial number, model number, and a brief description of the reason for your request. After you have all the pertinent information, we suggest you contact your selling dealer or local service company to set up an appointment. If you are not familiar with who is in your area, you can visit <https://shop.truefitness.com/store-locator/> and use our store locator to obtain the contact information for the closest dealer.

If you still need help, please contact our product support team.

Address	TRUE Fitness Attn: Product Support 865 Hoff Road St. Louis, MO 63366
Phone	800.883.8783
Email	service@truefitness.com
Hours of Operation	Monday - Friday 8:30am - 5:00pm (CST)

Contacting Our Sales Team

Interested in owning more TRUE products? Please contact us with any product inquiries so that we may direct you to the appropriate sales representative to help answer your questions.

Address	TRUE Fitness Attn: Sales Department 865 Hoff Road St. Louis, MO 63366
Phone	800.426.6570
Email	sales@truefitness.com
Hours of Operation	Monday - Friday 8:30am - 5:00pm (CST)

Reporting Freight Claims or Parts Damage

Unfortunately, sometimes materials can be damaged during shipment. If materials are damaged during shipment, please follow the guidelines below to determine the appropriate process for you to follow.

Severe Damage—Obvious damage to external packaging and internal product.

Please refuse the shipment and it will be returned to TRUE by the carrier. Contact TRUE product support by calling 800.883.8783 or sales support by calling 800.426.6570 Monday-Friday during normal business hours to notify us that the shipment has been refused. Once we have received the damaged shipment, a replacement shipment will be sent to you. If the shipment comes in multiple boxes, only refuse boxes with damage.

Slight Damage—Minimal damage to external packaging with unknown internal damage to product.

If the shipment has minimal damages and you are not sure if the actual product is damaged, you must sign the bill of lading as damaged when accepting the shipment. Once you have opened the box and you have determined something is indeed damaged, please gather the serial number, model number, description of damage, and photos of damage.

Please make sure the photos include the damaged product as well as the damaged box the product arrived in. Contact TRUE product support (service@truefitness.com // 800.883.8783) or TRUE sales support (sales@truefitness.com // 800.426.6570) Monday-Friday during normal business hours.

Concealed Damage—No damage to external packaging but internal damage to product.

You may receive a shipment that looks intact and discover once the box has been opened that there are hidden damages. Please notify the carrier immediately. TRUE will not be able to file a claim if the carrier is not notified in a timely manner.

Once you have called the carrier you will need to gather the serial number, model number, description of damage, and photos of damage. Contact TRUE product support (service@truefitness.com // 800.883.8783) or TRUE sales support (sales@truefitness.com // 800.426.6570) Monday-Friday during normal business hours.

TABLE OF CONTENTS

SAFETY INSTRUCTIONS

IMPORTANT SAFETY INSTRUCTIONS—SAVE THESE INSTRUCTIONS.....	7
POWER REQUIREMENTS.....	9
GROUNDING INSTRUCTIONS.....	9
WARNING AND INTENDED USE LABELS.....	10
COMPLIANCES.....	11

ASSEMBLY INSTRUCTIONS

PREASSEMBLY CHECKLIST.....	12
ASSEMBLY STEPS.....	13

CONSOLE OVERVIEW

CONSOLE OVERVIEW.....	17
-----------------------	----

PROGRAMMING AND OPERATION

HEART RATE MONITORING.....	18
HEART RATE CONTROL (HRC).....	19
PROGRAM DESCRIPTIONS.....	20

LCD CONSOLE

CONSOLE NAVIGATION.....	21
USER PROFILES.....	24
CREATING AND MANAGING A WORKOUT.....	26
UTILITY FUNCTIONS.....	32

WARRANTY

NOTICE.....	35
-------------	----

SAFETY INSTRUCTIONS

IMPORTANT SAFETY INSTRUCTIONS—SAVE THESE INSTRUCTIONS

This equipment is intended for a commercial or institutional setting. This owner's manual should be accessible to all personal trainers, faculty, and members.

- Read and understand all instructions and warnings prior to use.
- Obtain a medical exam before beginning any exercise program. If at any time during exercise you feel faint, dizzy, or experience pain, stop and consult your physician.
- Obtain proper instruction prior to use.
- This unit is intended for commercial use only.
- Inspect the unit for incorrect, worn, or loose components and do not use until corrected, replaced, or tightened prior to use.
- Do not wear loose or dangling clothing while using the unit.
- Care should be used when mounting or dismounting the unit.
- Read, understand, and test the emergency stop procedures before use.
- Disconnect all power before servicing the unit.
- Do not exceed maximum user weight of 350 lbs (159 kg).
- Keep the top side of the moving surface clean and dry.
- Keep children and animals away.
- Use caution when moving and assembling unit.
- All exercise equipment is potentially hazardous. If attention is not paid to the conditions of equipment usage, death, or serious injury could occur.

⚠ DANGER: To reduce the risk of electric shock, always unplug this product when not in use, before cleaning, or attempting any maintenance activity. Do not handle the plug with wet hands.

⚠ WARNING: To reduce the risk of burns, fire, and electric shock or injury to persons, follow these instructions:

- Heart rate monitoring systems may be inaccurate. Over-exercising may result in serious injury or death. If you feel faint, dizzy, or experience pain, stop exercising immediately.
- Health related injuries may result from incorrect or excessive use of exercise equipment.
- TRUE STRONGLY recommends seeing a physician for a complete medical exam before undertaking an exercise program, particularly if the user has a family history of high blood pressure or heart disease, is over the age of 45, smokes, has high cholesterol, is obese or has not exercised regularly in the past year. Additionally, TRUE recommends consulting a fitness professional on the correct use of this product.
- Equipment should be immediately taken out of use if it fails to work properly or when a warning is presented electronically.
- When using this exercise machine, basic precautions should always be followed.
- Use this equipment only for its intended use as described in this manual.
- Do not move the equipment by lifting the console. Do not use the console as a handlebar during a workout.
- This product can expose you to chemicals including Toluene and Acrylamide which are known to the State of California to cause Cancer and birth defects or other reproductive harm. For more information, go to www.P65Warnings.ca.gov.
- Keep equipment stable on flat ground.
- Risk of personal injury-crushing hazard when equipment is in operation. Keep feet, hands, and fingers away from moving parts.
- Replace warning labels that may be worn, damaged, or missing.
- Replace any non-working or damaged components, remove the unit from service until repair is performed.
- Do not operate the equipment while being covered with a blanket, pillow, plastic, or anything that insulates or stops airflow. Keep air openings free of lint, hair or any obstructing material.
- To avoid serious injury, remove and store the power cord when the machine is not in use.
- This appliance should never be left unattended when plugged in.
- Do not use any type of extension cord with this product.
- Never operate a TRUE product if it has a damaged power cord or electrical plug, or if it has been dropped, damaged, or even partially immersed in water.
- Use a TRUE AC power cord or AC/DC adapter only.
- Position this product so the power cord plug is accessible to the user.

- Keep the power cord away from heated surfaces. Do not pull the equipment by the power cord or use the cord as a handle. Do not run the power cord along the side or under the equipment.
- If the electrical supply cord is damaged it must be replaced by the manufacturer, an authorized service agent, or a similarly qualified person to avoid a hazard.
- This product must be connected to a properly grounded electrical outlet.
- To disconnect, turn power OFF at the ON/OFF switch if applicable, then remove plug from electrical outlet. On the machine power switch, (I) means that the machine power is **ON** and (O) means the machine power is **OFF**.

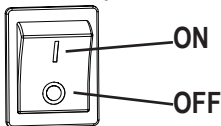

- Never insert objects into any openings in this product. If an object should drop inside, turn off the power, unplug the power cord from the outlet and carefully retrieve it. If the item cannot be reached, contact TRUE product support.
- Any changes or modifications to this equipment could void the product warranty.
- Do not use this product in areas where aerosol spray products are being used or where oxygen is being administered. Such substances create the danger of combustion and explosion.
- Do not use this product outdoors, near water, while wet, or in areas of high humidity including extreme temperature changes.
- Close supervision is necessary when used near children under the age of 15, or disabled persons.
- This equipment is not intended for use by persons with reduced physical, sensory, or mental capabilities, or lack of experience and knowledge, unless they are supervised or have been given instruction concerning use of the equipment by a person responsible for their safety.
- Children shall not play with the appliance.
- Cleaning and user maintenance shall not be made by children without supervision.
- Wear shoes with rubber or high traction soles. Do not use shoes with heels, leather soles, cleats or spikes. Make sure no stones are embedded in the soles. Do not use this product in bare feet. Keep all loose clothing, shoelaces and towels away from moving parts.
- To avoid injury, attach the safety clip to clothing before use.
- When mounting the treadmill, ensure the treadmill belt is not running.
- Use handlebars to maintain balance when mounting and dismounting the treadmill and for additional stability while exercising.
- To avoid injury, stand on the side rails before starting the equipment.

- While the treadmill is in use, proceed at a speed that the user can safely maintain with the ability to immediately engage the safety key to stop the treadmill belt if necessary.
- Avoid the possibility of bystanders being struck or caught between moving parts by making sure that they are out of reach of the equipment while it is in motion.
- Do not use typing or web surfing features at excessive speeds. Always stabilize yourself when using typing or web surfing features. (Varies by console option.)
- Never place liquids of any type directly on the unit except in the accessory tray or bottle holders. Containers with lids are recommended.
- Always follow the console instructions for proper operation.
- Do not use the contact heart rate grips as a handlebar during a workout.
- Avoid exiting equipment while leaving the tread belt in motion.
- Never walk or jog backwards on the equipment.
- Allow only one person at a time on the equipment while it's operating.
- Do not allow animals on or near the equipment while in operation.
- To avoid serious injury, do not touch the incline rack while the equipment is in use.

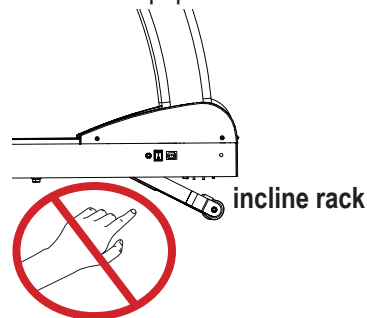

- To avoid serious injury, do not touch the belt while the equipment is in use.

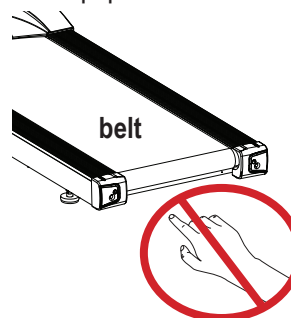

- Do not reach into or underneath the unit, or tip it on its side during operation.
- Do not use if you have a cold or fever.
- Do not change the incline of the equipment by placing objects under it.
- Do not use attachments not recommended by the manufacturer.
- Allow only trained personnel to service this equipment.

- It is the sole responsibility of the owner/operator to ensure regular and scheduled maintenance is performed.
- Do not remove the motor cover or you may risk injury due to electric shock. Please contact TRUE product support if the motor area needs servicing.
- Noise emission under load is higher than without load. A-weighted emission sound pressure level at the trainer's ear: 67 dBA.

POWER REQUIREMENTS

Read and understand all instructions before plugging any TRUE power cord into an electrical outlet.

DEDICATED LINE

This product requires a dedicated line. A dedicated line assures that adequate power is available for safe operation over the life of your TRUE product.

GROUNDING INSTRUCTIONS

This product must be grounded. If the product malfunctions or breakdowns, grounding provides a path of least resistance for electric current to reduce the risk of electric shock. This product is equipped with a cord having an equipment grounding conductor and a grounding plug. The plug must be plugged into an appropriate outlet that is properly installed and grounded in accordance with all local codes and ordinances.

DANGER:

- Improper connection of the equipment grounding conductor can result in risk of electrical shock.
- Check with a qualified electrician or service provider if you are in doubt as to whether the equipment is properly grounded or installed on a dedicated line.
- Seek a qualified electrician to perform any modifications to the cord or plug. TRUE is not responsible for injuries or damages as a result of cord or plug modification.
- To reduce the risk of burns, fire, electric shock, or injury, it is imperative to connect each product to a properly grounded 110V or 220V electrical outlet. The voltage required for your unit is located on the serial number decal (usually on the front of the unit). Depending on where you live voltage requirements differ.
- Some TRUE products require a circuit rated 110V, 60 Hz, and 20 amps. In the United States, most residential homes have circuits rated 110V, 60 Hz, and 15 amps. If your unit requires a 20 amp outlet, contact an electrician to install a dedicated 20 amp circuit prior to use.
- **110 Volt**—This model is for use on a nominal 110V circuit and has a grounding plug that looks like the plug illustrated below. Make sure the product is connected to an outlet having the same configuration as the plug. No adapter should be used with this product.

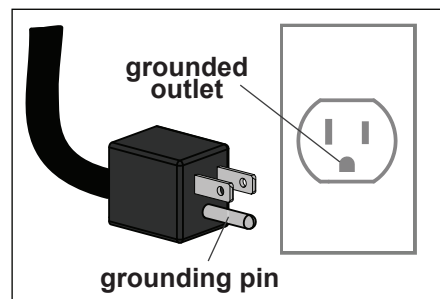

Power Information						
Model	Line Voltage (V)	Frequency (Hz)	Rated Current (Amps)	Number of Units per Circuit	Plug/Outlet*	Max Power Dissipation (Watt)
TPS1000/3000/8000	110	50/60Hz	15	Dedicated 1	NEMA 5-15 	1230

*The plug configuration for the power adapter may vary by country.

WARNING AND INTENDED USE LABELS

! WARNING: Replace warning labels that may be worn, damaged, or missing.

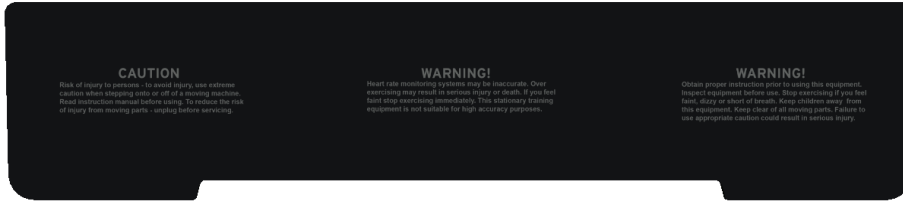

To replace any worn or missing warning labels, locate the serial number for your product, and then contact TRUE product support:

- www.truefitness.com
- 800.883.8783
- service@truefitness.com

NOTE: Additional console serial number located at the bottom of the console.

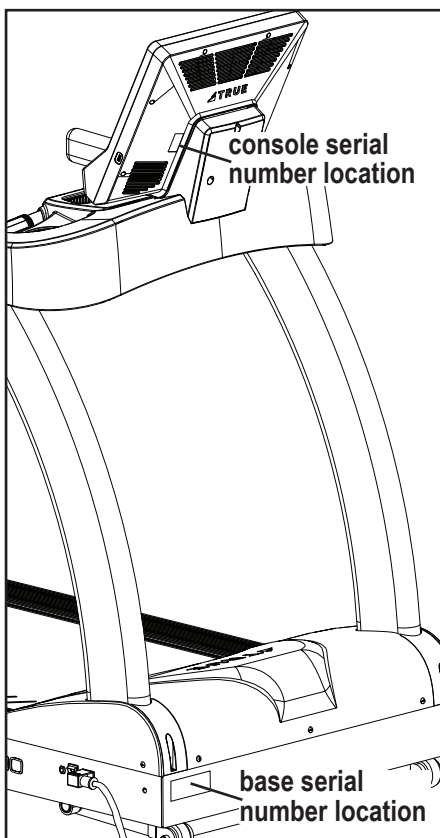

23-000000X

TRUE
 TRUE FITNESS TECHNOLOGY, INC
 865 HOFF RD, ST LOUIS MISSOURI 63366 USA
 MODEL NO: TPS1000
 SERIAL NO: 22-TPS10001A

TRUE
 TRUE FITNESS TECHNOLOGY, INC
 865 HOFF RD, ST LOUIS MISSOURI 63366 USA
 MODEL NO: TPS3000
 SERIAL NO: 22-TPS30001A

TRUE
 TRUE FITNESS TECHNOLOGY, INC
 865 HOFF RD, ST LOUIS MISSOURI 63366 USA
 MODEL NO: TPS8000
 SERIAL NO: 22-TPS80001A

WARNING AND INTENDED USE LABELS CONTINUED

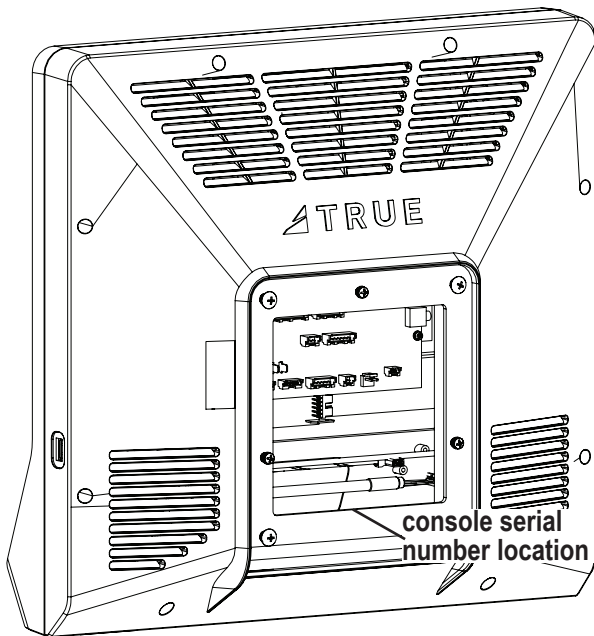

S/N: 
23-000000X

MDL: 
C4RL

COMPLIANCES

This equipment complies with all applicable codes and regulations. For a complete list of compliances, please see regulatory approvals on truefitness.com.

ASSEMBLY INSTRUCTIONS



NOTE: Supplemental video available on vimeo.com: <https://vimeo.com/869706867?share=copy>.

PREASSEMBLY CHECKLIST

VERIFY BOX CONTENTS

IMPORTANT! Please verify box contents. If you have questions, or if there are any missing parts, contact product support at 800.883.8783 or service@truefitness.com.

TOOLS NEEDED FOR ASSEMBLY		INCLUDED IN BOX
#2 Phillips Screwdriver		NO

BOX CONTENTS

ITEM	PART NUMBER	DESCRIPTION	QTY
1	C4RL	CONSOLE, UCIV, RETAIL LCD	1
2	MAN-C4RL	MANUAL, C4RL	1

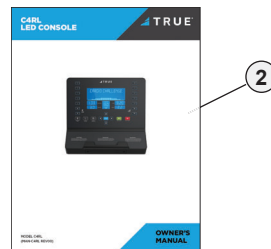
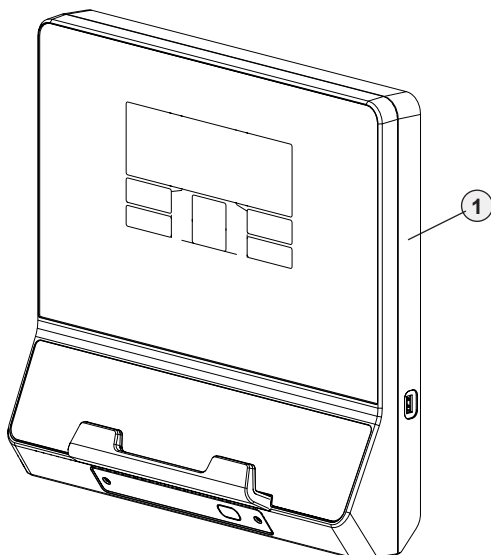

ASSEMBLY STEPS

STEP 1—ATTACH CONSOLE TO CONSOLE MAST

Tools Used in this Step	
#2 Phillips Screwdriver	

Parts Used in this Step		
Part	Description	Qty
N/A	CONSOLE	1

Using a #2 Phillips screwdriver, secure the console to the console mast using the hardware preassembled to the console (00567800 // SCREW, M5-.8X12 COMBO PHILLIPS/Common TRUSS HEAD - ACG BLACK // QTY 4).

NOTE: If the console also has three screws (00567700 // SCREW, M4-.7 X 12 PPHMS SEMS // QTY 3) preassembled, remove and set aside these screws. They are not used in this installation.

NOTE: Loosen but do not remove the bottom two preassembled screws (00567800), those slide into the keyhole slots on the console mast.

NOTE: Ensure all cables are routed inside the console mast to avoid pinching the cables.

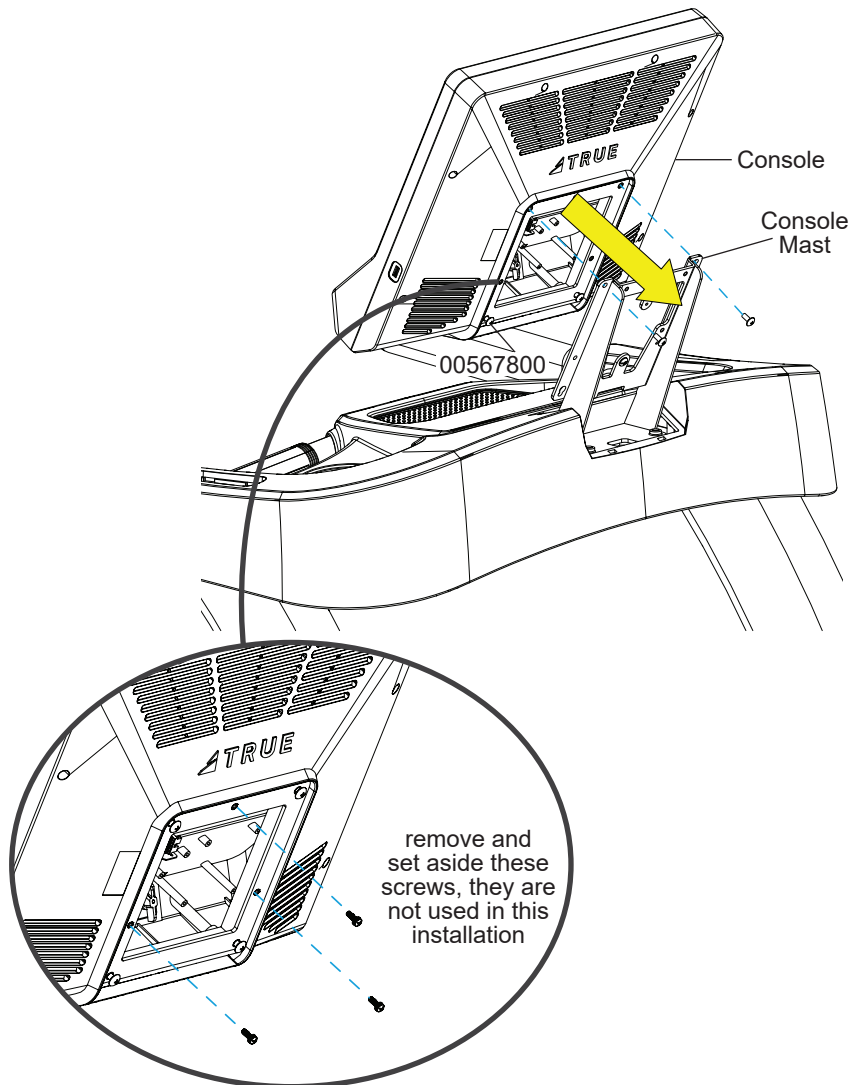

STEP 2—MAKE CONSOLE CABLE CONNECTIONS

1. Connect the I/O cable, center pod cable, contact heart rate cable, and safety key cable to their respective ports on the console control board.

NOTE: The shorter safety key connector pictured below is only used for the LCD console. The longer connector will not be used.

2. Connect the three ground wire ring terminals to the preinstalled, grounded screw on the console mast, ensuring the grounded screw secures the ground wire ring terminals to the front console mast. Ensure all ground wire rings are connected.

NOTE: Coaxial cable connections are not available on the LCD console at this time.

NOTE: Ensure there is power going to the machine. See the base owner's manual for power cord info.

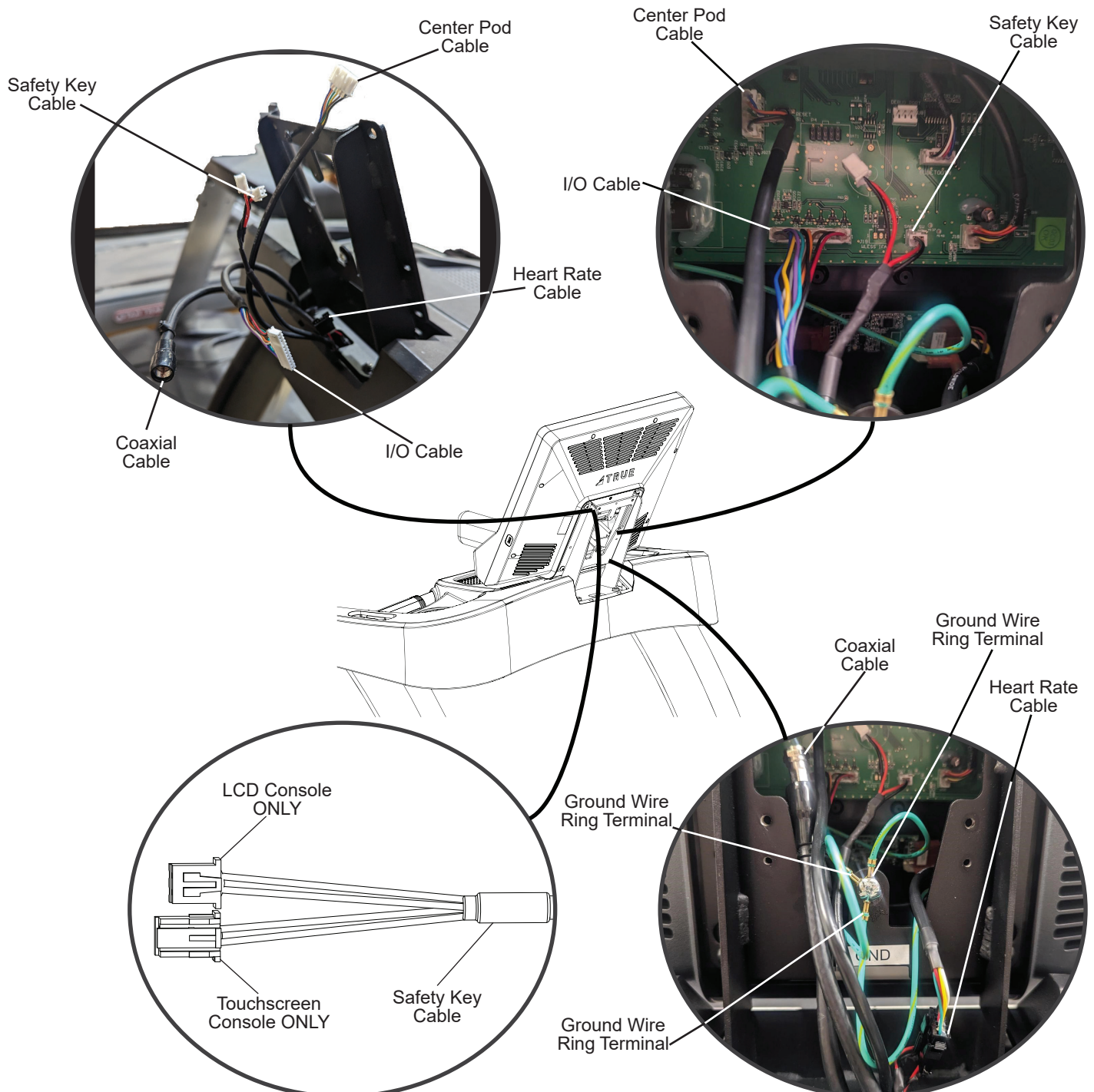

STEP 3—CALIBRATE THE TREADMILL

NOTE: Supplemental video available on vimeo.com: <https://vimeo.com/869672159?share=copy>.

PART	DESCRIPTION	QTY
N/A	CONSOLE	1

NOTE: For instructions on product setup and calibration, see **Utility Functions** on page 34.

STEP 4—ATTACH REAR CONSOLE COVER

Tools Used in this Step	
#2 Phillips Screwdriver	

Part	Description	Qty
T10076	PHCS, M4XP0.7X12	3
TPS9109	COVER, REAR CONSOLE, TPS, BLACK	1

Using a #2 Phillips screwdriver, attach the rear console cover to the console mast using 3 screws.

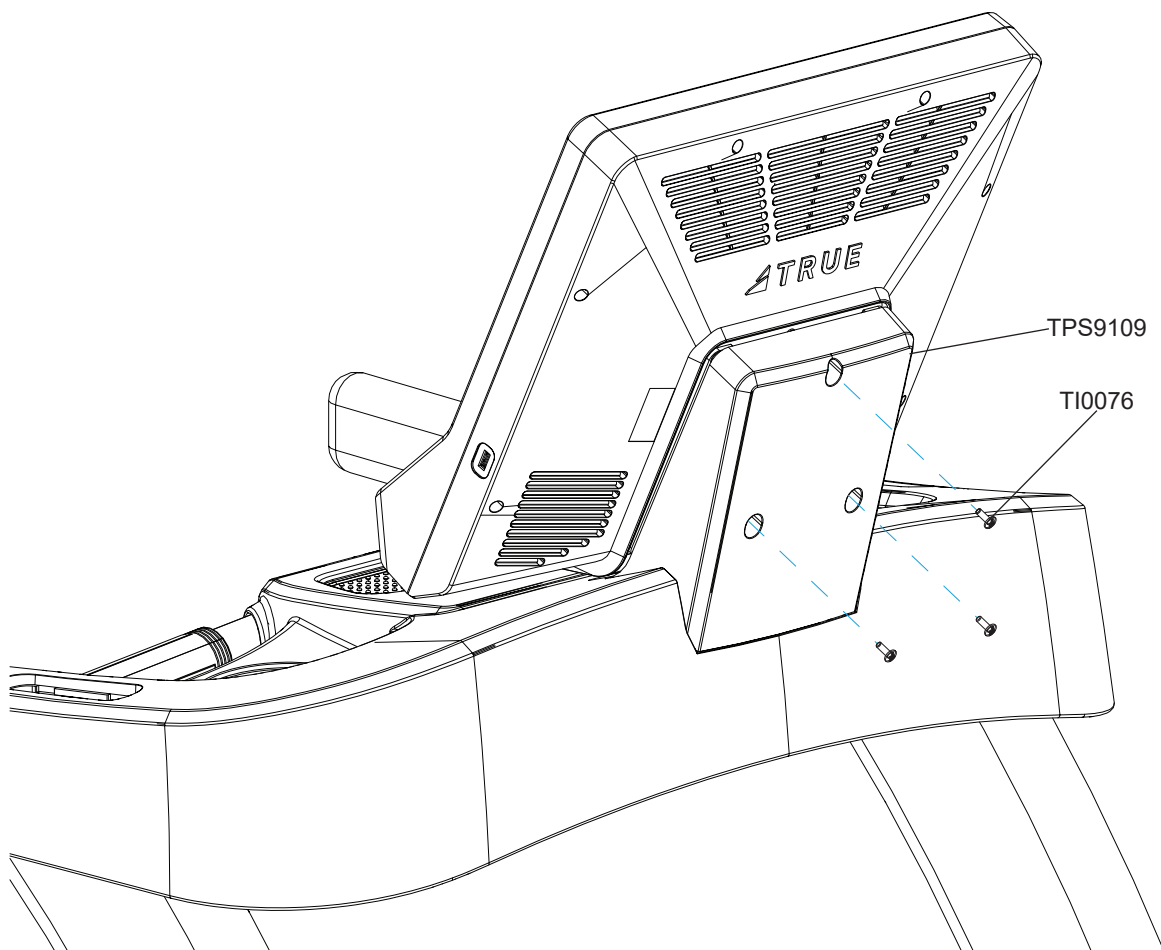

CONSOLE OVERVIEW

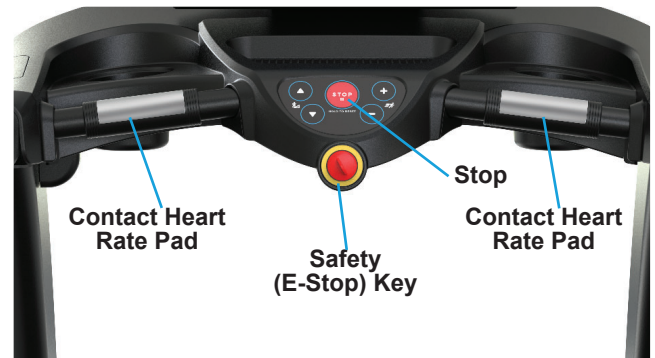
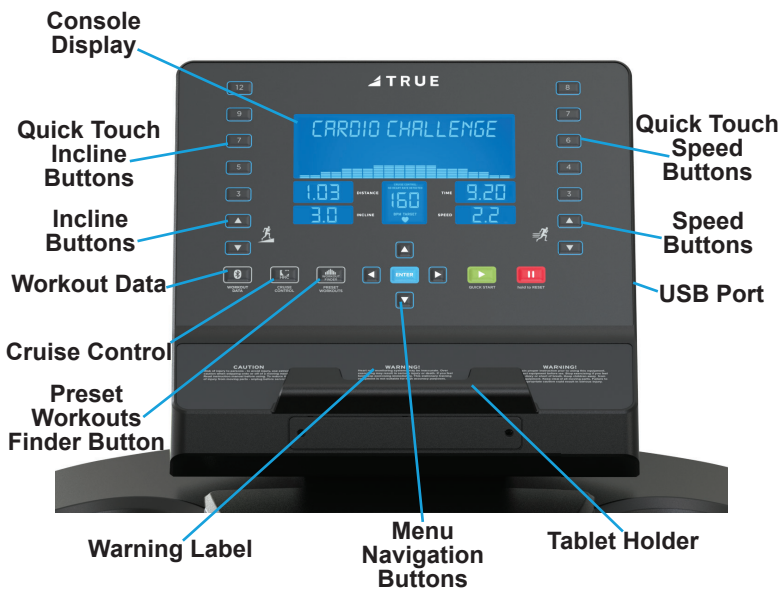

Console Display

Used to monitor and/or control workouts and for feature navigation.

Incline Buttons

Manually increases or decreases the incline of the treadmill.

Quick Touch Incline Buttons

A group of 5 buttons that can set the incline percentage to preset levels of 3%, 5%, 7%, 9%, and 12%.

USB Port

Used to update console software.

Warning Label

Important safety information for users to review prior to using the equipment.

Stop

Stop/pauses a workout. Press and hold this button for five seconds to reset the unit.

Speed Buttons

Manually increases or decreases the speed of the belt.

Quick Touch Speed Buttons

A group of 5 buttons that can set the treadmill to preset speeds of 3 mph, 4 mph, 6 mph, 7 mph, and 8 mph.

Tablet Holder

A mount designed to hold mobile devices during a workout.

Contact Heart Rate Pads

Allows the user to check their heart rate without wearing a wireless chest strap. For increased safety and accuracy this feature should only be used when the belt speed is below 4 mph.

Safety (E-Stop) Key

A tethered safety device designed to attach to both the user and the treadmill. Removal of the key from the treadmill will stop belt motion to prevent injury in an emergency. The safety key must be in place on the treadmill, and should be attached to the user's clothing. The treadmill will not operate if the safety key is not attached to the treadmill.

Preset Workouts Finder Button

Allows the user to page through the various preset workout programs available (see Program Descriptions).

Menu Navigation Buttons

Allows the user to page through and change various options within a workout (or during a workout setup) using the four **Menu Navigation** buttons and then accept a particular option by pressing **ENTER**.

Cruise Control

Engages heart rate control to allow the equipment to maintain the user's current heart rate through automatic speeds and incline adjustments (when the user is utilizing heart rate monitoring).

Workout Data

Allows the user to capture workout data on their smartphone via Bluetooth.

PROGRAMMING AND OPERATION

HEART RATE MONITORING

This treadmill can monitor a user's heart rate using a Polar* 5kHz compatible chest strap, a Bluetooth heart rate transmitter or the metal grips on the hand rails (called contact heart rate or CHR pads). Bluetooth transmitters and chest straps transmit the user's heart rate to the treadmill via radio, and the console reads the user's heart rate.

Chest Strap and Bluetooth Heart Rate Monitoring

Although this treadmill functions fine without using the heart rate monitoring feature, this kind of monitoring gives valuable feedback on the user's effort level. Using chest strap or Bluetooth monitoring also allows users to use Heart Rate Control, the most advanced exercise control system available. When users wear a Polar® compatible transmitter strap or a Bluetooth transmitter, the treadmill will display the user's heart rate as a digital beats-per-minute (bpm) readout. A chest strap should be worn directly against the user's skin, about 1-2 inches below the pectoral muscles/breast line. Women should be careful to place the transmitter below their bra line. *Bluetooth transmitters should be worn in accordance with the manufacturer's documentation. Initially the transmission signal for heart rate may be erratic or non-existent. Some moisture is necessary between the strap and the user's skin for proper transmission. Sweat from exercise works best, but ordinary tap water may be used prior to the workout if desired.

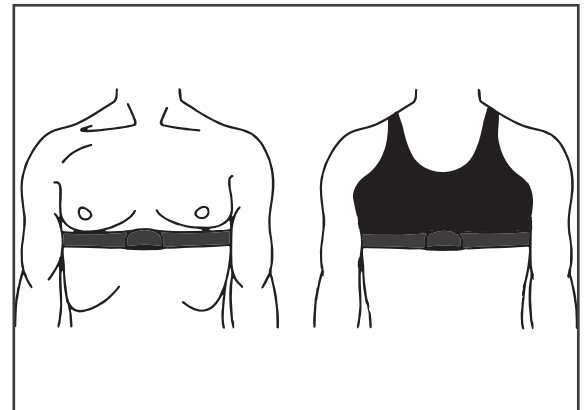

NOTE: The chest strap produces a radio signal that the treadmill reads and registers as the user's heart rate. The accuracy of a reading may be affected when outside interference is present.

Contact Heart Rate (CHR)

The CHR system will let the user monitor their heart rate without wearing a chest strap. When using the CHR system users should gently grasp the CHR pads with both hands. Within 30 seconds, the user's heart rate should be displayed as a digital bpm readout (during the first 30 seconds the system is analyzing and locking in the user's heart rate). Users should exercise with smooth body motions and breathe regularly. It is best to avoid talking while using the CHR system, as talking will cause unrepresentative heart rate spikes of 5 to 10 bpm. To ensure an accurate reading, the user's hands should be clean, free of both dirt and hand lotions.

NOTE: For increased safety and accuracy the CHR system should only be used at speeds of 4 mph or lower (CHR readings are less accurate due to large muscle movements above this speed).

NOTE: CHR monitoring may be less accurate than chest strap monitoring since the heart rate signals are much stronger at the chest. When using a HRC workout, it is best to use a chest strap because of the stronger and more accurate readings. Do not use the contact heart rate grips as a handlebar during a workout.

⚠ CAUTION: Do not use the contact heart rate grips as a handlebar during a workout.

HEART RATE CONTROL (HRC)

You are now the owner of the most sophisticated Heart Rate Control (HRC) treadmill available. TRUE HRC is unique and patented. It accommodates users from rehabilitation to world class athletes, and all those in between. TRUE HRC allows users to do a completely hands-free heart rate controlled workout using speed, incline or both. By training at a specific target heart rate, users can exercise at a more efficient cardiovascular level.

The TRUE HRC system is unique because users must enter the key parameters of the workout; target heart rate, maximum speed, maximum incline, and time, prior to beginning the HRC workout. As users approach their target heart rate, the treadmill's computer automatically takes over and changes the speed and/or incline automatically to keep users near their target heart rate. This allows for a completely "hands-free" workout.

NOTE: A Bluetooth or Polar® compatible heart rate monitoring chest strap should be worn during HRC workouts. For increased safety and accuracy, contact heart rate monitoring is not recommended for HRC workouts.

Target Heart Rate

TRUE's Heart Rate Control (HRC) workouts let the treadmill monitor relative exercise intensity by way of the user's heart rate, then automatically adjust the speed and incline to keep the user at their target heart rate and thus their desired exercise intensity. Heart rate is a good measure of the body's exercise stress level. It reflects differences in physical condition, fatigue, the comfort of the workout environment, even diet and emotional state. Users should compare their heart rate with how they feel to ensure safety and comfort.

Consult a physician to determine heart rate

Using heart rate to control a workout takes the guesswork out of the workout settings. Consult a physician before using heart rate controlled workouts for advice on selecting a target heart rate range. Also, it is important to use the treadmill for several workouts in the manual mode while monitoring heart rate. Users should compare their heart rate with how they feel to ensure safety and comfort. After users have spent some time learning how their heart responds to different levels of speed and incline, they will have a better understanding of how to select the maximum speed and maximum incline required for reaching their target heart rate.

Warm Up

At the beginning of an HRC workout, the treadmill is in full Manual Control mode. Users should gradually increase the workout intensity to slowly raise their heart rate to within 10 beats per minute (bpm) of their target heart rate. The treadmill will operate as if in manual mode during the warm up stage. Users control both speed and incline. The user may only increase speed and incline to the present maximum values entered. It is important that the user starts at a low level of perceived exertion and gradually increase the workout intensity over several minutes until they approach their target heart rate. This allows the body to adapt to the workout. Increasing the workout intensity gradually will allow the user to enter the Heart Rate Control stage without overshooting their target, keeping their heart rate within a few bpm of their target.

NOTE: Warming up too fast may cause the user to overshoot their target. If this occurs it may take several minutes before the computer software can control their heart rate. Users may overshoot and undershoot for several minutes until control is achieved.

Heart Rate Control Stage

The treadmill takes control of speed and incline, keeping the user's heart rate within a few bpm of their target. When using the Interval HRC Workout, the treadmill alternates between work and rest intervals.

Cool Down

At the end of the workout time or distance, the treadmill reduces the workout intensity by half and goes back into Manual Control mode, where users directly control their cooldown.

PROGRAM DESCRIPTIONS

Quick Start

A workout in which the user controls all settings. The workout continues until it is ended by the user.

Manual

Users enter their weight, workout time, or distance. The user controls both the SPEED and INCLINE of the treadmill throughout the workout.

Hill Intervals

Hill Intervals are in two minute segments with the speed remaining constant. Speed changes are permanent; incline changes affect the current two minute segment only.

Rolling Hills

A series of gradually increasing and decreasing incline changes that simulate rolling hills.

Cardio Challenge

Speed and incline increase to a maximum at the mid-point of the workout, then decrease to the finish. Incline and speed changes affect the current segment only.

Walk and Run Intervals

Walking then running intervals in one minute segments. Incline changes are permanent; speed changes affect the current segment only.

Speed Ramp

Speed increases to a maximum at the mid-point of the workout, then decreases to the finish. Speed changes affect the current segment only. Incline changes are permanent.

5K Workout

A popular distance run. Users choose their speed and the workout will end at 5 kilometers (3.1 miles). The user can control both the SPEED and INCLINE of the treadmill throughout the run.

10K Workout

A challenging distance run. Users choose their speed and the workout will end at 10 kilometers (6.2 miles). The user can control both the SPEED and INCLINE of the treadmill throughout the run.

Half Marathon

A very challenging distance run. Users choose their speed and the workout will end at 21 kilometers (13.1 miles). The user can control both the SPEED and INCLINE of the treadmill throughout the run.

LCD CONSOLE

CONSOLE NAVIGATION

Home Screen

The Home Screen is displayed on the console when the machine first comes on or is reset by pressing **STOP II** when there is no workout in progress. There are two possible Home Screens: one with **User Profiles** turned on and one with **User Profiles** turned off. New machines are delivered with **User Profiles** turned off.



Home Screen with **User Profiles** Turned On

Starting from the Home Screen with **User Profiles** turned on, the user is able to select from various options using the **QUICK START** ► button, the **Menu Navigation** buttons, the **Workout Finder** button, the **Cruise Control (HRC)** button, and/or the **Workout Data** button to do the following:

1. Begin a Quick Start workout.
2. Select a preset workout.
3. Input any required preworkout data.
4. Begin and control a selected workout from the console.
5. Create a User Profile (four possible User Profiles).
6. Select an existing User Profile.
7. Edit a previously created User Profile.
8. Display and start a previously created workout.
9. Setup Cruise Target HRC for a selected User Profile.
10. Initiate a Bluetooth session with a smart phone using apps like GymTrakr to capture the workout data from the current workout session to the phone wirelessly.
11. Stop and reset the machine.



Home Screen with **User Profiles** Turned Off

Starting from the Home Screen with **User Profiles** turned off, the user is able to select from various options using the **QUICK START** ► button, the **Menu Navigation** buttons, the **Workout Finder** button, the **Cruise Control (HRC)** button, and/or the **Workout Data** button to do the following:

1. Begin a Quick Start workout.
2. Select a preset workout.
3. Setup Cruise Target HRC workout.
4. Initiate a Bluetooth session with a smart phone using apps like GymTrakr to capture the workout data from the current workout session to the phone wirelessly.

CONSOLE NAVIGATION CONTINUED

Example - Using the Console Panel Navigation to Start a Workout

To begin a workout, press **QUICK START** ▶ (A). Press **Workout Finder** (C) to access new, preset workouts. The **Console Display** (B) shows a visual representation of the workout format. When additional user data is required, use the **Menu Navigation** buttons (D) to select/modify the data field. When the data field displays the correct value, press **ENTER** (E) to accept it. After all data is accepted, the workout will begin.



Lower Panel



Quick Access Keys
(Double as numeric increment keys for workout data entry.)

Workout Data Entry Screens

These screens allow users to input their personal information or workout goals prior to beginning a workout. To set a value, use the **incline up** ▲ **and down** ▼ buttons or the **+** **and - speed** buttons on the lower panel (next to the **STOP II** button) or the **up and down Menu Navigation buttons** on the console to increase or decrease the number value. Once the desired value has been reached, press **ENTER** on the console to accept the setting and move to the next entry screen.

NOTE: The information required through Workout Data Entry Screens varies by workout program selection.

Age Adjustment Entry Screen



Set Age number value

Weight Adjustment Entry Screen



Set Weight number value

CONSOLE NAVIGATION CONTINUED

Workout Data Screen



A. Distance Display

Displays the current Distance traveled (in miles), measured from the beginning of the workout up to the present instant.

B. Incline Display

Displays the current level of incline as a percentage up from level. The incline level can be changed by pressing the **incline up ▲** and **down ▼** buttons or by selecting a specific **Quick Incline** button (i.e. 3%; 5%; 7%; 9% or 12%).

C. HR Display/HRC Cruise Control Display

Displays monitored Heart Rate during a workout. Also part of HRC Cruise Control, which allows the equipment to maintain the user's current heart rate during the workout through automatic speed and incline adjustments (when the user is utilizing heart rate monitoring).

D. Time Display

Displays the time elapsed since the start of the workout. Time stops incrementing if **STOP II** is pressed to pause the workout and resumes if the workout is restarted in less than 30 seconds.

E. Speed Display

Displays the current treadmill speed (mph). The speed can be changed by pressing the **+ and - speed** buttons or by selecting a specific **Quick Speed** button (i.e. 3 mph, 4 mph, 6 mph, 7 mph, or 8 mph).

F. Main Console Workout Display

Displays Workout Data and Workout Graphics, which allows the user to monitor and adjust the workout as it happens.

USER PROFILES

Creating a New User Profile

To create a new user profile, do the following:

1. Display the Home (HELLO greeting) Screen (if it is not displayed, hold **STOP II** until it appears). USER 1? will be displayed by default. For the following example, USER 2? is used:

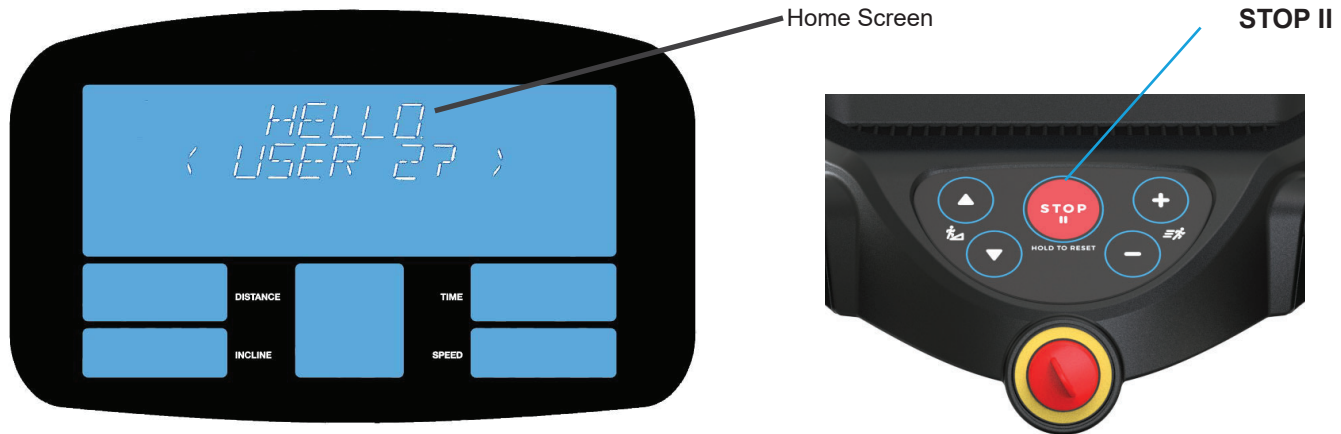

2. Use the **left and right Menu Navigation** buttons to select one of the four profiles available.

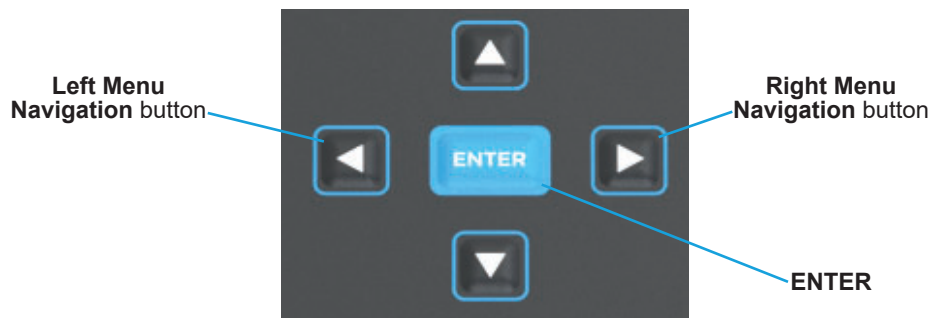

3. Once the desired user number is displayed, push and hold **ENTER** on the console until the EDIT USER(#) screen appears.

NOTE: The number of user profiles is limited to four.

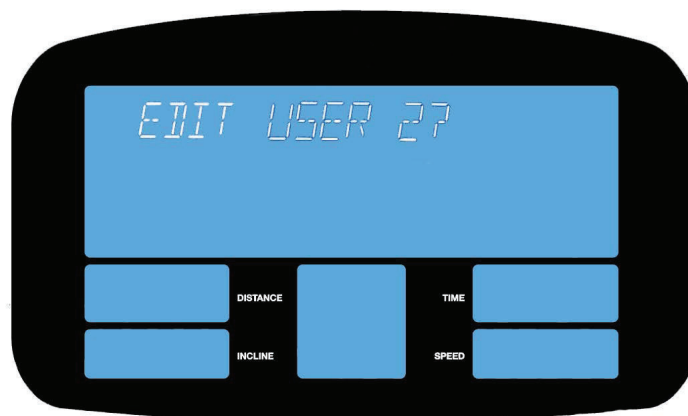

USER PROFILES CONTINUED

4. Push and hold the **up and down Menu Navigation** buttons on the console to enter the user name, one character at a time. Use the **right and left Menu Navigation** buttons to move to the next character position or back to a previous letter in the name.



5. When the name has been entered correctly, press **ENTER** on the console to accept it and move to the next entry screen.
6. Repeat these steps, using the **up and down Menu Navigation** buttons on the console to increase or decrease the required number values (Example: the age and weight entries in the screens above). Once the correct value is displayed, always accept the entry by pressing **ENTER**.
7. When the last profile data has been accepted, the unit will indicate that the user's profile data is **SAVED** with the following screen.



8. It will then display a screen asking the user to choose a workout (see the next section, **Creating and Managing a Workout**).

Editing an Existing User Profile

1. Display the User Profile to be edited by following steps 1 and 2 in **Creating a New User Profile** (above).
2. Press and hold **ENTER** on the console.
3. The **EDIT (PROFILE NAME)** screen will appear.
4. Follow Steps 4 through 8 in **Creating a New User Profile** (above) to edit the data in the User profile.

CREATING AND MANAGING A WORKOUT

Beginning a Quick Start Workout

1. Bring up a pre-existing User Profile on the Console Display (C).
2. Press **QUICK START** ▶ (G).
3. A ¼ mile, manual (track) workout will come up, count down from 3 and start at 0 incline and .5 mph speed. The user will have total control over the speed and incline during the workout.



CREATING AND MANAGING A WORKOUT CONTINUED

Setting Up and Starting a New, Preset Workout

Workout

1. Bring up a pre-existing User Profile on the Console Display (C).
2. Press **ENTER** (B) and use the **right (M) and left (O) Menu Navigation** buttons to scroll to NEW WORKOUT? (C).
3. Press **Workout Finder** (I) on the console to scroll through the nine preset workout options available:
 - Manual
 - Hill Intervals
 - Rolling Hills
 - Cardio Challenge
 - Walk and Run Intervals
 - Speed Ramp
 - 5k Workout
 - 10k Workout
 - Half Marathon
4. When the desired workout is displayed, press **ENTER** (B) on the console to select it.
5. The next several screens may ask for preworkout setup data (preset data) such as age, weight, desired workout time, incline level, distance and/or speed. Setup each requested parameter using the **up (L) and down (N) Menu Navigation** buttons on the lower panel and then press **ENTER** (B) to accept it.
6. The last screen will ask to save this workout to the selected User Profile. Press **ENTER** (B).
7. The next screen will ask which of the five Workout Preset Data Storage Areas does the user want this workout to be saved to (each User Profile has five Workout Preset Data Storage Areas available).

NOTE: Saving new workout preset data into a Workout Data Storage Area that already has workout preset data stored in it will overwrite the existing data with the new data. The old data will be lost.
8. Choose the Workout Data Storage Area desired by pressing the **up (L) and down (N) Menu Navigation** buttons.
9. When the desired storage area is displayed, press **ENTER** (B) to select it. The screen will say WORKOUT SAVED (C).
10. After a brief pause, a countdown from 3 will commence and the selected workout will begin.



CREATING AND MANAGING A WORKOUT CONTINUED

Starting One of the Five Previously Saved Workouts Under a Selected User Profile

1. Bring up a pre-existing User Profile on the Console Display (C).
2. Press **ENTER** (B) on the console.
3. A screen will appear that says LAST WORKOUT? (C) and L1 will show in the **HR Detector** (P) display box.
4. Press the **right** (M) **Menu Navigation** button once.
5. The screen will display the first of five workouts saved under the selected User Profile. S1 (S=Saved workout) will appear in the center **HR Detector** (P) display box.
6. Press the **up** (L) **Menu Navigation** button repeatedly to page through the five Workout Data Storage areas. The S# in the **HR Detector** (P) display box will cycle from S1 through S5 and the workouts shown on the **Console Display** (C) will reflect what workout is saved in each Workout Preset Data Storage area.
7. When the desired workout comes up, press **ENTER** (B) to select it.
8. After a brief pause, a countdown from 3 will commence and the selected workout will begin.



CREATING AND MANAGING A WORKOUT CONTINUED

Starting One of the Ten Previous Workouts Automatically Captured from all User Profiles

NOTE: The treadmill automatically stores the last ten workouts performed on it in a “stack” designated as **L** (L=Last Workout). Each time a new workout is ran, it is saved into storage area L1 and all of the other stored workouts move up in the stack by one position. So, every time a new workout is added in L1, the oldest stored workout in L10 is erased.

1. Bring up a pre-existing User Profile on the Console Display (C).
2. Press **ENTER** (B) on the console.
3. A screen will appear that says LAST WORKOUT? (C) and L1 will show in the **HR Detector** (P) display box.
4. Press the **up** (L) **Menu Navigation** button repeatedly to page through the ten Last Workout Data Storage areas. The L# in the **HR Detector** (P) display box will cycle from L1 through L10 and the workouts shown on the Console Display will reflect what workout is saved in each Last Workout Preset Data Storage area.
5. When the desired workout comes up, press **ENTER** (B) to select it.
6. After a brief pause, a countdown from 3 will commence and the selected workout will begin.



Cruise Control (HRC) Workouts

The TRUE Heart Rate Control (HRC) workouts are unique because users must enter the key parameters of the workout; target heart rate, maximum speed, maximum incline, and time, prior to beginning the HRC workout. As users approach their target heart rate, the treadmill’s computer automatically takes over and changes the speed and/or incline automatically to keep users near their target heart rate. This allows for a completely “hands free” workout.

*A Bluetooth or Polar® compatible heart rate monitoring chest strap should be worn during HRC workouts. For increased safety and accuracy, contact heart rate monitoring is not recommended for HRC workouts.

CREATING AND MANAGING A WORKOUT CONTINUED

Setting Up the Target Heart Rate Control Workout

TRUE's heart rate control (HRC) workouts let the treadmill monitor relative exercise intensity by way of the user's heart rate, then automatically adjusts the speed and incline to keep the user at their target heart rate and thus their desired exercise intensity. Heart rate is a good measure of the body's exercise stress level. It reflects differences in physical condition, fatigue, the comfort of the workout environment, even diet and emotional state. Users should compare their heart rate with how they feel to ensure safety and comfort.

1. Start at the Home Screen on the **Console Display (C)**.
2. Press **HRC (J)** on the console. A screen will display showing **TARGET HRC (C)**.
3. Choose Target HRC and then press **ENTER (B)** on the console. A series of set-up screens will be displayed. They will require the following data entries:
 - Age
 - Weight
 - Time (workout duration)
 - Target Heart Rate
 - Maximum Speed
 - Maximum Incline
4. The next screen will ask which of the five Workout Preset Data Storage Areas does the user want this workout to be saved to (each User Profile has five Workout Preset Data Storage Areas available).

NOTE: Saving new workout preset data into a Workout Data Storage Area that already has workout preset data stored in it will overwrite the existing data with the new data. The old data will be lost.
5. Choose the Workout Data Storage Area desired by pressing the **up (L) and down (N) Menu Navigation** buttons.
6. When the desired storage area is displayed, press **ENTER (B)** to select it. The screen will say **WORKOUT SAVED (C)**.

7. Make sure whichever heart monitoring method to be used (Bluetooth or Polar® compatible heart rate monitoring chest strap or direct contact) is in place.
8. After a brief pause, a countdown from 3 will commence and the HRC workout will begin.



CREATING AND MANAGING A WORKOUT CONTINUED

Warm Up

At the beginning of an HRC workout, the treadmill is in full Manual Control mode. Users should gradually increase the workout intensity to slowly raise their heart rate to within 10 beats per minute (bpm) of their target heart rate. The treadmill will operate as if in manual mode during the warm up stage. Users control both speed and incline. The user may only increase speed and incline to the present maximum values entered. It is important that the user starts at a low level of perceived exertion and gradually increase the workout intensity over several minutes until they approach their target heart rate. This allows the body to adapt to the workout. Increasing the workout intensity gradually will allow the user to enter the heart rate control stage without overshooting their target, keeping their heart rate within a few bpm of their target.

NOTE: The information required through Workout Data Entry Screens varies by workout program selection.

Heart Rate Control Stage

The treadmill takes control of speed and incline, keeping the user's heart rate within a few bpm of their target. When using the Interval HRC Workout, the treadmill alternates between work and rest intervals.

Cool Down

At the end of the workout time or distance, the treadmill reduces the workout intensity by half and goes back into Manual Control mode, where users directly control their cooldown.

HRC Workout Summary

Once the workout is complete, a Workout Summary will be displayed.

Workout Summary

NOTE: At the end of every workout, whether it ends normally or ends by being stopped by the user before completion, a series of Workout Summary screens will be displayed and will cycle three times. These screens could include Time; Average Heart Rate; Maximum Heart Rate; Average Speed; Maximum Speed; Average Incline; Maximum Incline; Distance and Calories burned. There are two ways to capture this data. One is to write it down as it is displayed. The other is to transfer it to a smartphone through a Bluetooth application.

Using a Bluetooth Application

1. If a user owns a smartphone, there are mobile applications from TRUE and other sources (i.e. GymTrakr).
2. Press **Workout Data** (I) on the console. The screen will say BLUETOOTH ID (C) and a four digit pairing code number.
3. Use the app to pair the mobile device to the treadmill (this process varies by mobile application).
4. Press **QUICK START** ▶ (G) or begin a previously saved workout.
5. After ending a workout, the Workout Summary data will be uploaded automatically through a Bluetooth transmission from the treadmill and stored by the app on the smartphone.

Write it down

1. Each Workout Summary screen (C) displays its data for two seconds and all of the screens are shown three times in a repeating cycle.
2. Have a pen and pad ready to write down the Workout Summary data.



UTILITY FUNCTIONS

Utilities Options Menu - Maintenance Mode

Product setup under maintenance mode allows the user (or, preferably, a certified technician) to adjust the model configuration and setup.

To enter maintenance mode:

1. Remove and replace the safety key (A) or power off/ on allowing time for the base unit to initialize and display the home screen.
2. Press and hold incline up ▲ (B) until it beeps for a second time (3-5 seconds) and then release.
3. Press and hold **ENTER** (C) until it beeps for a second time (3-5 seconds) and MAINTENANCE MODE (D) appears on the console display.
4. Press **ENTER** (C) again and DIAGNOSTICS (D) appears.
5. Use the incline up ▲ (B) and down ▼ (E) to scroll through the available options: DIAGNOSTICS, CONFIGURATION, and CALIBRATION. To select an option press **ENTER** (C).
6. Use the speed up ▲ (F) and down ▼ (G) to make adjustments and press **QUICK START** ▶ (H) to save the changes. Once finished, press **STOP II** (I) to navigate back through the menu options or return to the home screen.
7. Once all changes are complete, remove and replace the safety key (A) allowing the base unit to initialize. All changes will be saved upon returning to back to the home screen.

There are three sub menus located within the maintenance mode main menu:

- Diagnostics
- Configuration
- Calibration

Diagnostics

- **Total Time**
The amount of time that the machine has run since the last reset.
- **Total Distance**
The number of miles that the belt has moved since the last reset.
- **Average Speed**
The overall speed that the belt has averaged since the last reset.
- **Units**
Determines how the workout data is displayed (English or Metric) by default.
- **Sleep**
The amount of time the unit can be idle before entering sleep mode. By choosing the **Off** setting, the unit will remain powered on indefinitely.



UTILITY FUNCTIONS CONTINUED

- **Cool Down**

Adjusts the length of the cooldown time at the end of a workout.

- **Pause (On or Off)**

Limits the amount of time that a workout can be paused until the user resumes or ends the workout.

- **Error Log**

Error codes are an important part of troubleshooting any issues with the treadmill. Any time an error occurs it is entered into the error log for review by a service professional. (Example: Fault Indicator 1 - Incline Stall). This console is capable of storing the ten most recent errors. The speed up ▲ and down ▼ allow a user to page through them.

- **User Profiles (On or Off)**

Enables or disables the custom user profile feature.

NOTE: Turning **User Profiles** off, saving the setting and then turning it back on and saving it again will clear off all user profile data and saved workouts (both **L** and **S** type) on the machine. This is, in effect, the master data reset.

Configuration

Gives access to the Model Number, specification for maximum speed and incline percentage, overall time the machine has run and distance the belt has moved, the cooldown duration setting, the Heart Rate Controls Test, the Keys Test, the Display Test and the EPROM Test.

UTILITY FUNCTIONS CONTINUED

IMPORTANT! CALIBRATION IS REQUIRED AFTER THE CONSOLE IS INSTALLED TO THE BASE.

NOTE: Users must select the correct base in configuration prior to calibration.

To enter configuration:

1. Remove and replace the safety key (A) or power off/on allowing time for the base unit to initialize and display the home screen.
2. Press and hold incline up ▲ (B) until it beeps for a second time (3-5 seconds) and then release.
3. Press and hold **ENTER** (C) until it beeps for a second time (3-5 seconds) and **MAINTENANCE MODE** (D) appears on the console display.
4. Press **ENTER** (C) again and **DIAGNOSTICS** (D) appears.
5. Use the incline up ▲ (B) and down ▼ (E) to scroll through the available options. When **CONFIGURATION** (D) appears press **ENTER** (C).
6. Use the incline up ▲ (B) and down ▼ (E) to scroll through the available options. When a base model number appears press **ENTER** (C).
7. Use the speed up ▲ (H) and down ▼ (I) to select the correct base model and press **QUICK START** ▶ (F) to save the changes.

To enter calibration:

1. Press **STOP II** (G) and **CONFIGURATION** (D) appears.
2. Use the incline up ▲ (B) and down ▼ (E) to scroll through the available options. When **CALIBRATION** (D) appears press **ENTER** (C).
3. Press **QUICK START** ▶ (F) to start the calibration process.
 - ⚠ **WARNING:** This process will take full control of the treadmill and can be dangerous if caution is not taken.
 - Calibration can take up to two minutes to complete.
 - Do not stand on the treadmill during the calibration procedure.
 - Verify that the machine is free of all parts and tools.
 - Keep children and animals at a safe distance.
4. The treadmill will begin adding PWM to achieve a target speed of 0.5 mph, 6.0 mph, and 12.0 mph (0.8 to 19.3 km/h). During the speed calibration the treadmill will also set the incline range from 0% to 15%.



5. The console will display **CALIBRATION PASS** or a fault code if one is detected.



6. Once finished, press and hold **STOP II** (G) to navigate back through the menu options and return to the home screen.
7. Remove and replace the safety key (A) allowing the base unit to initialize.
8. Once calibration is complete, turn the power off on the treadmill for 30 seconds.

WARRANTY

NOTICE

For unit and console warranty information, refer to the Warranty Information chapter in the unit manual.

T R U E F I T N E S S . C O M



TRUE Fitness Technology, Inc | 865 Hoff Road, St. Louis, MO 63366

© 2024 TRUE. All Rights Reserved.